

TONSIL

50

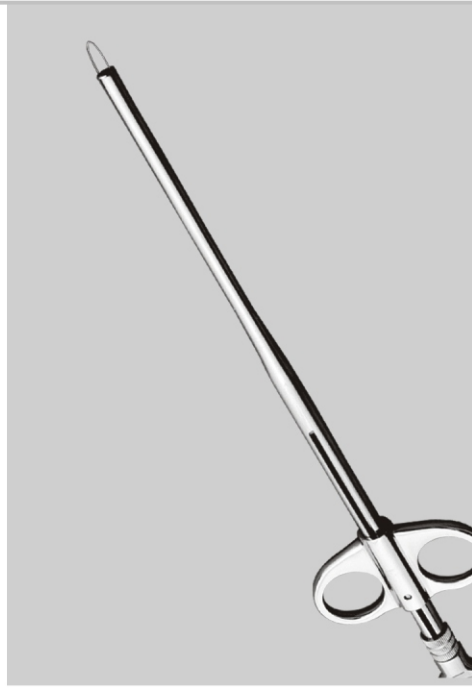

PAGE 001 to 015



- EN Tonsil
- DE Tonsil
- ES Amígdala

SERVING HEALTHCARE WORLDWIDE



TONSIL

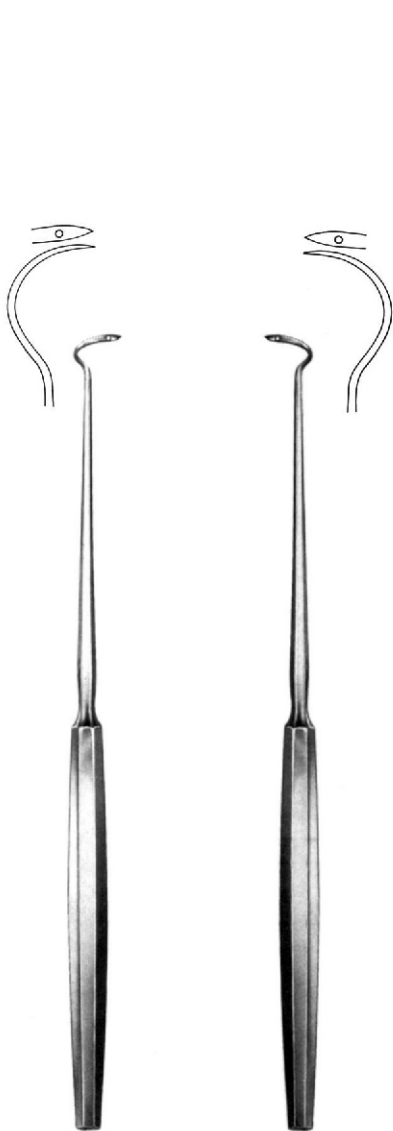

HURD
50.0010.21 21.0cm 50.0012.21

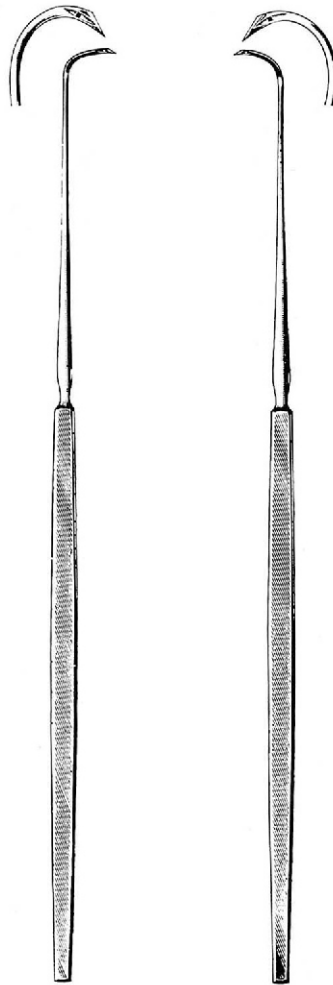

DURHAM
50.0020.25 25.0cm 50.0022.25

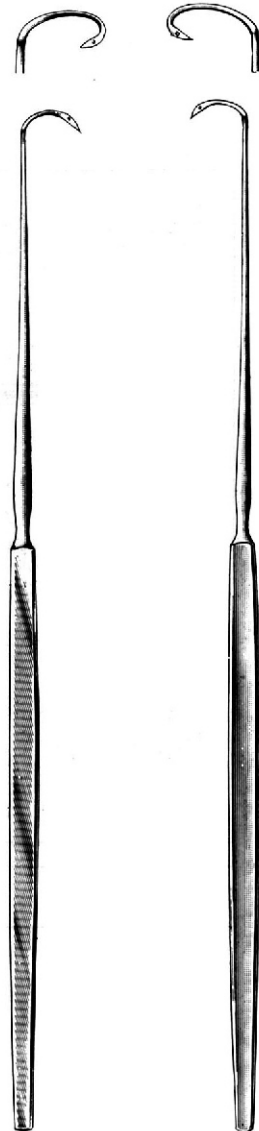

ROTTER
50.0030.26 26.0cm 50.0032.26

50.0032.26

50-001

www.hilbro.net

50

EN Tonsil Needles

DE Tonsillennadeln

ES Agujas para suturas de amígdalas

Hilbro

TONSIL



NAGER
50.0040.24 24.0cm

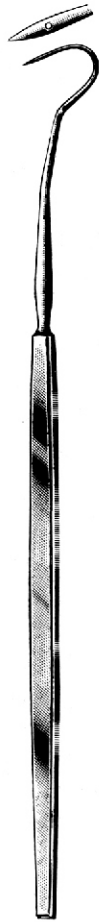

CLAUS-EICKEN
50.0046.23 23.0cm

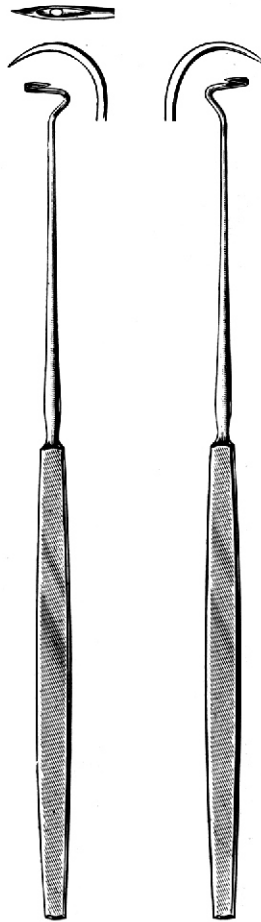

DUPUY-WEISS
50.0050.22 22.0cm 50.0052.22



FALK
50.0060.24 24.0cm 50.0062.24

50.0062.24

50-002

www.hilbro.net

Tonsil Knives EN

Tonsillenmesser DE

Bisturries ES

50

TONSIL

Hilbro



BRUENINGS
50.0070.23 23.0cm



ABRAHAM
50.0074.21 21.0cm



FISHER
50.0080.22 22.5cm



COLVER
50.0084.22 22.5cm

50.0084.22

50-003

www.hilbro.net

50

EN Tonsil Knives and Dissector

DE Tonsillennmesser und Dissektoren

ES Bisturios p / amígdalas y disecadores

Hilbro

TONSIL

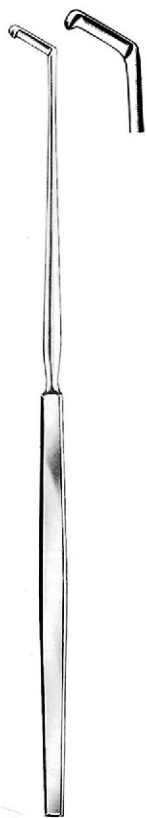

DOUGLAS
50.0090.21 21.0cm



CANFIELD
50.0094.21 21.0cm



TYDING
50.0100.21 21.0cm



LYNCH
50.0104.20 20.0cm



DAY
50.0110.21 21.5cm

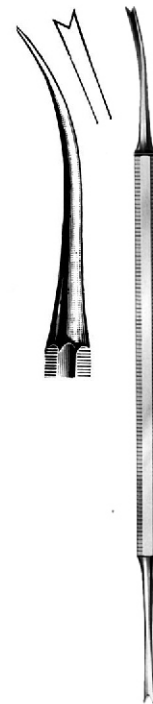

LUNIATSCHEK
50.0114.19 19.0cm

50.0114.19

50-004

www.hilbro.net

Tonsil Knives, Dissectors, Enucleators, Retractor etc. EN
 Tonsillenmesser, dissektoren, Enukleator, Retraktor usw. DE
 Bisturías, disecadores, enucleador, separador etc. ES

50

TONSIL



HURD
50.0120.22 22.5cm

HENKE
50.0124.23 23.0cm

HENKE
50.0130.23 23.0cm

CARPENTER
50.0134.25 25.0cm

CARPENTER
50.0140.24 24.0cm

50.0140.24

50-005

www.hilbro.net

50

EN Dissectores, Enucleator, Retractor etc.

DE Dissektoren, Enukleator, Retraktor usw.

ES Disecadores, enucleador, separador etc.

Hilbro

TONSIL

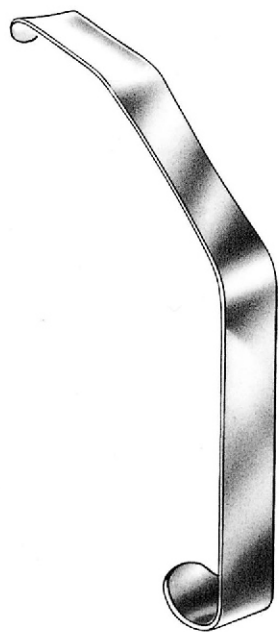

LOVE

15.0cm

50.0150.18 18mm

50.0150.20 20mm

50.0150.22 22mm

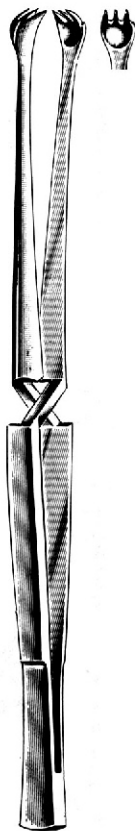

MARSCHIK

50.0154.22 22.0cm

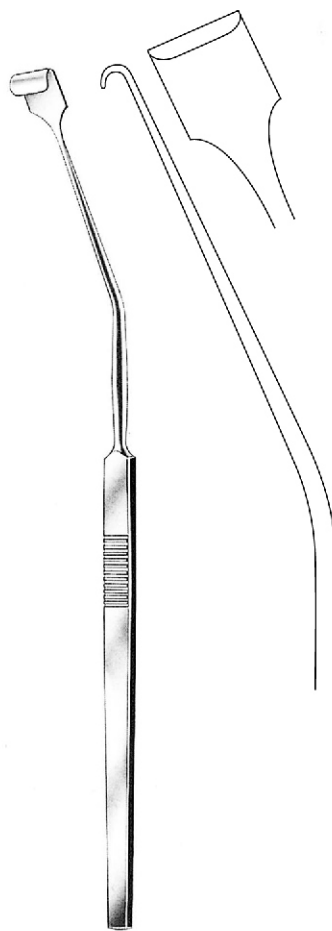

NAGER

50.0160.24 24.0cm

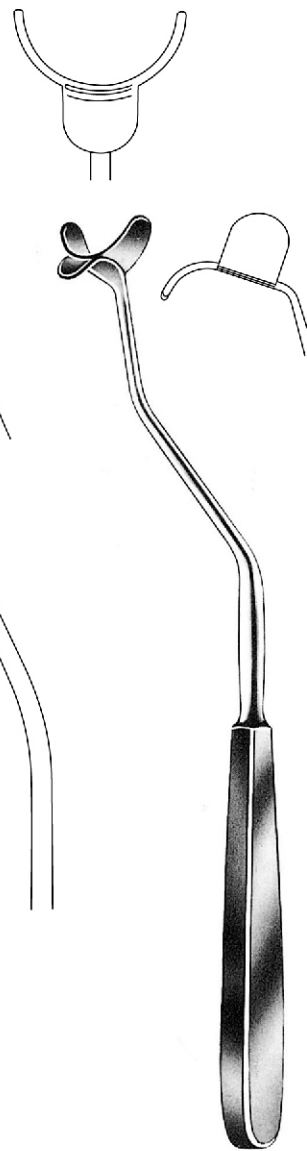

HOFER

50.0164.24 24.0cm

50.0164.24

50-006

www.hilbro.net

TONSIL

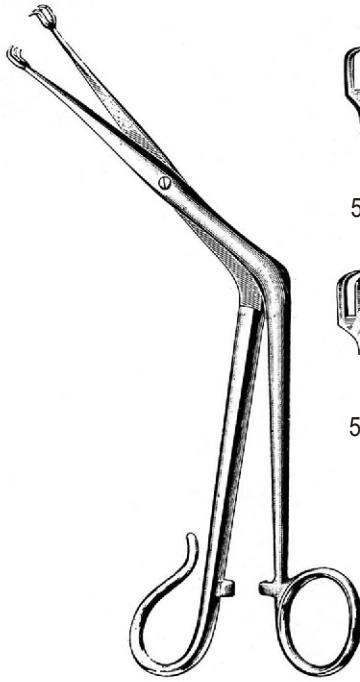

TIVNEN-TYDING
21.0cm

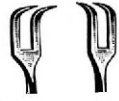

Fig. 1
50.0170.21

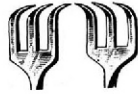
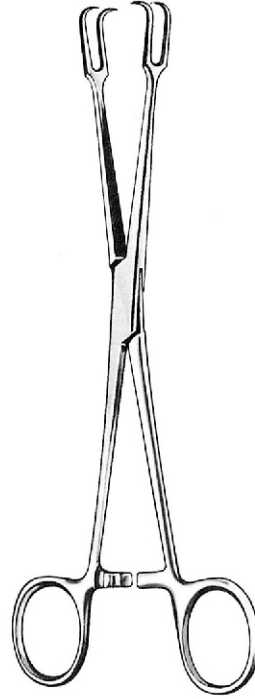
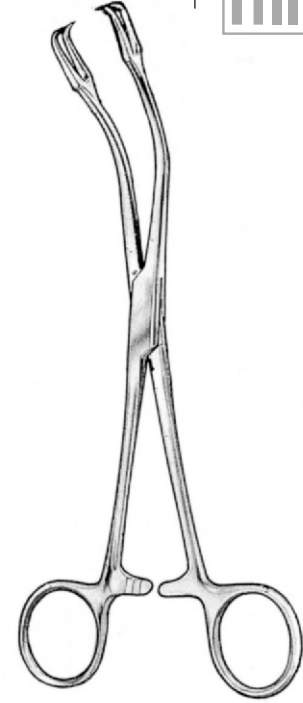

Fig. 2
50.0172.21



MUSEUX
50.0180.20 20.0cm



MUSEUX
50.0181.20 20.0cm

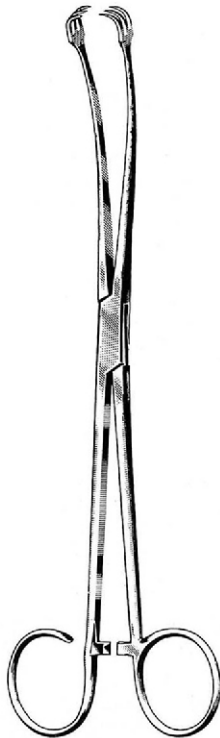

BALLENGER
50.0184.21 21.5cm



WHITE
50.0190.18 18.0cm
50.0190.23 23.0cm



50.0194.19

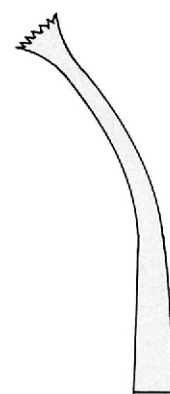

50.0195.19

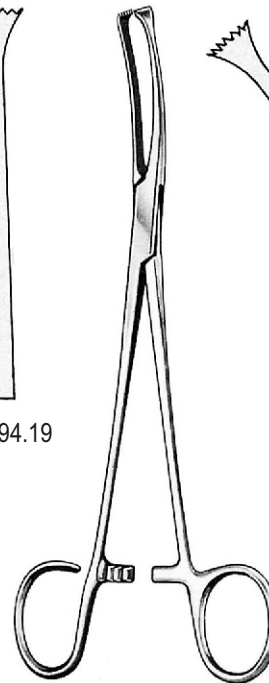

COLVER
19.0cm

50.0195.19

50-007

www.hilbro.net

TONSIL

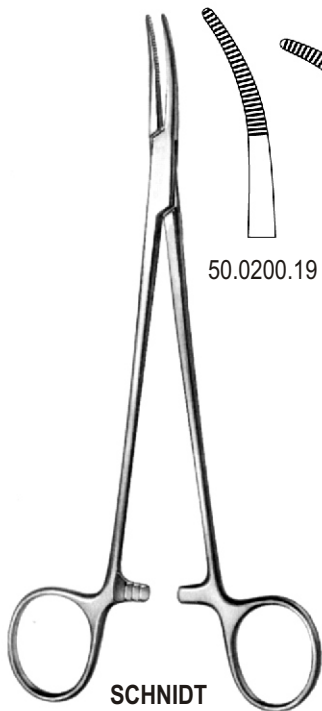

SCHNIDT
19.0cm

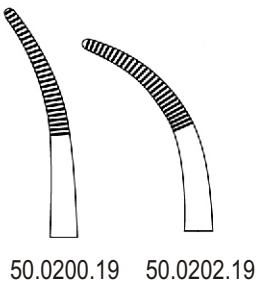

50.0200.19 50.0202.19

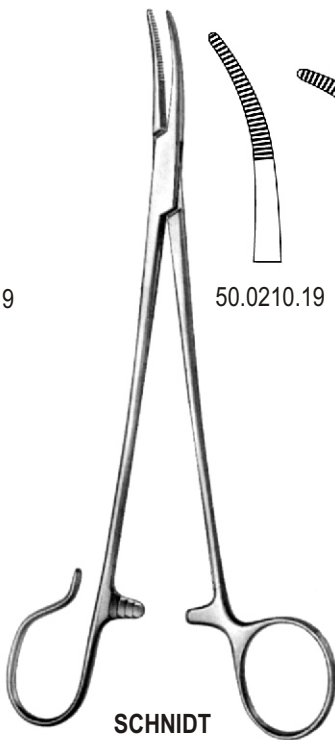

SCHNIDT
19.0cm

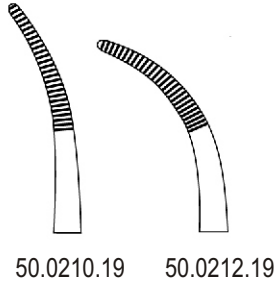

50.0210.19 50.0212.19



BLOHMKE
20.0cm

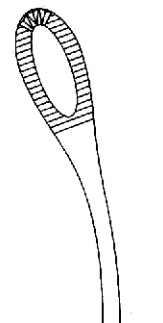

50.0216.20

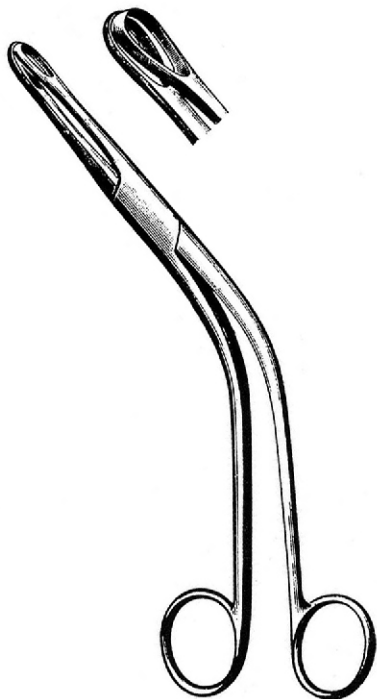

DENIS-BROWNE
50.0220.18 18.0cm
50.0220.21 21.0cm

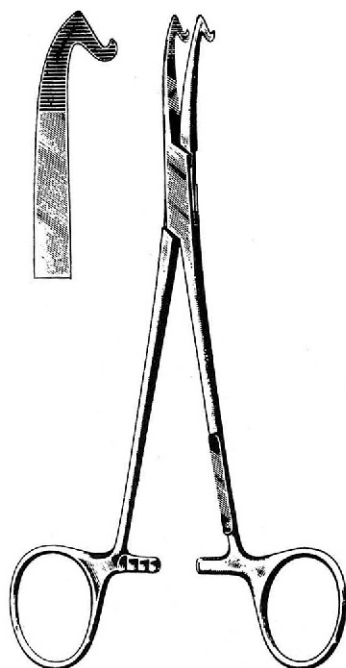

McWHOPTER-LOTHROP
50.0224.18 18.0cm

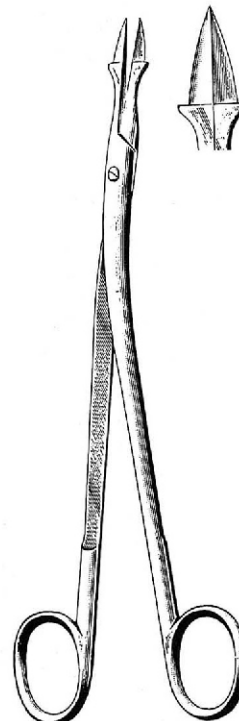

THILENIUS
50.0228.20 20.0cm

50.0228.20

50-008

www.hilbro.net

TONSIL

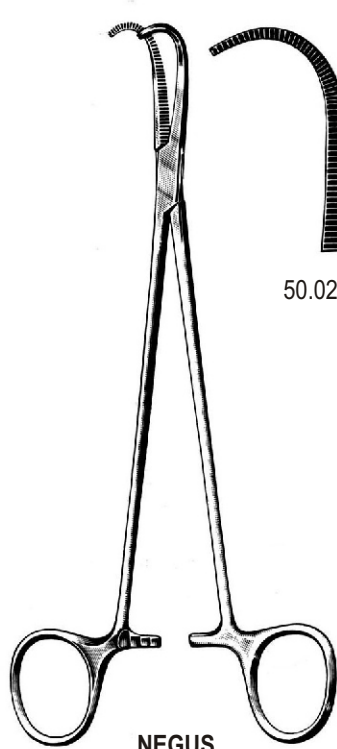

NEGUS
19.0cm



50.0230.19



50.0232.19

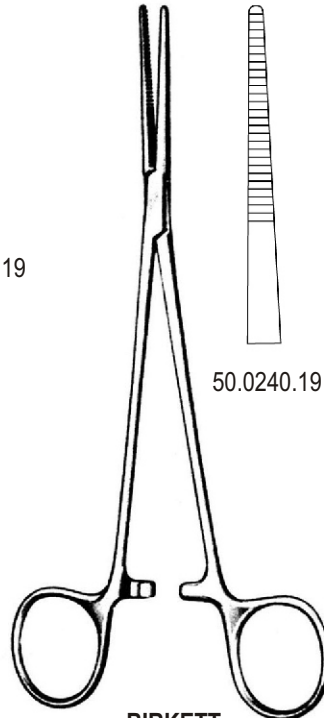

BIRKETT
19.0cm



50.0240.19



50.0241.19

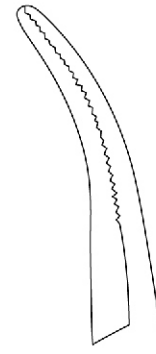

50.0243.19

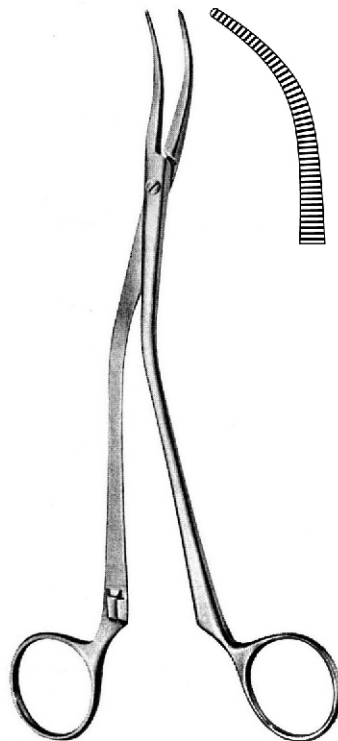

WILSON
50.0250.19 19.0cm

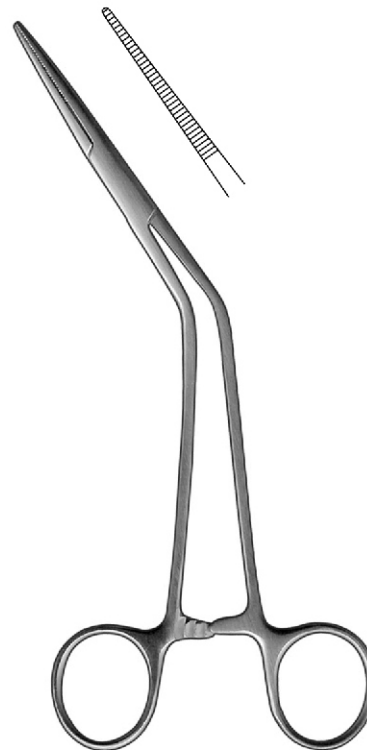
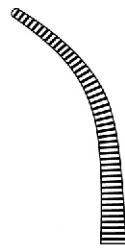

MOLLISON
50.0254.18 18.0cm (with horizontal opening)
50.0256.18 18.0cm (with vertical opening)

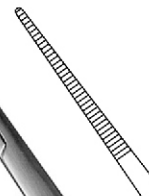

50.0256.18

50-009

www.hilbro.net

50

- EN Tonsil Snares
- DE Tonsillenschnürer
- ES Cierra-nudos para amígdalas

Hilbro

TONSIL



EVES
50.0260.28 28.0cm



EVES
50.0270.28 28.0cm



BRUENINGS
50.0280.28 28.0cm

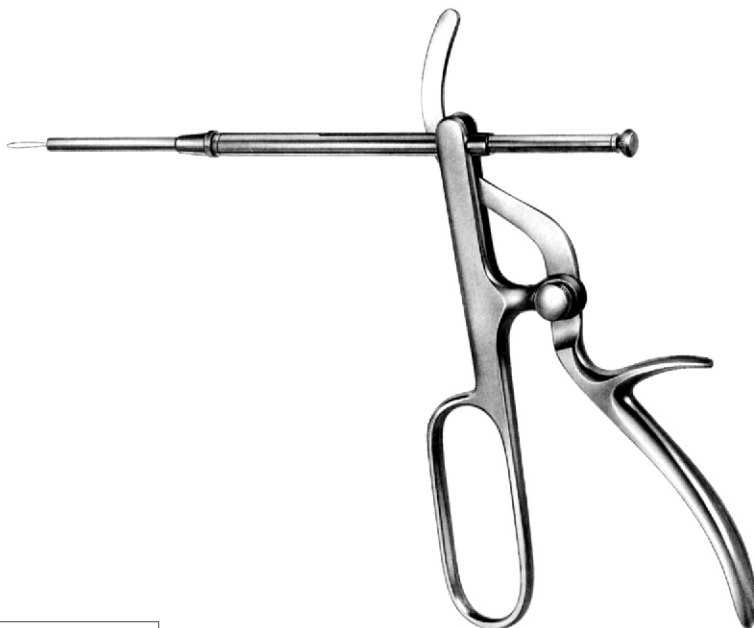

TYDING
50.0290.00

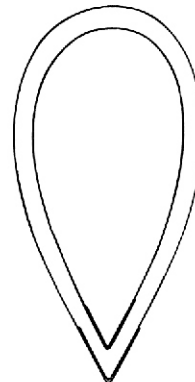

50.0300.40 40mm
50.0300.50 50mm



50.0306.03 0.3mm Ø

50.0306.03

50-010

www.hilbro.net

Tonsillectomes EN

Tonsillotome DE

Amigdalotomos ES

50

TONSIL

Hilbro

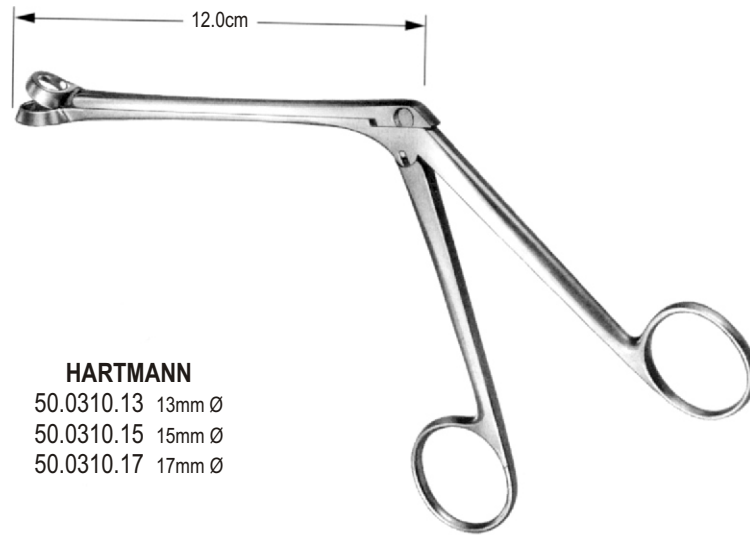

HARTMANN

50.0310.13 13mm Ø

50.0310.15 15mm Ø

50.0310.17 17mm Ø

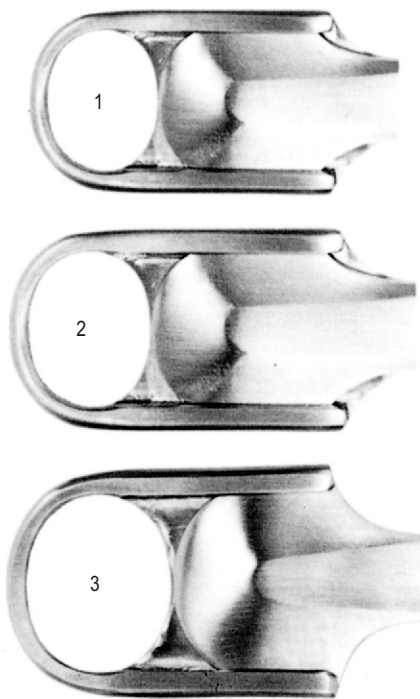

SLUDER-BALLENGER

50.0320.00 compl.

3-tips

50.0320.01

50.0320.02

50.0320.03

50.0320.03

50-011

www.hilbro.net

EN Universal Handles and Interchangeable Tubes, Broncho-Esophagoscopy Forceps

DE Universalgriffe und Verlängerungsrohre, Broncho-Oesophagoskopiezangen

ES Mangos universales y tubos de extension, pinzas para bronco-esofagoscopia



TONSIL

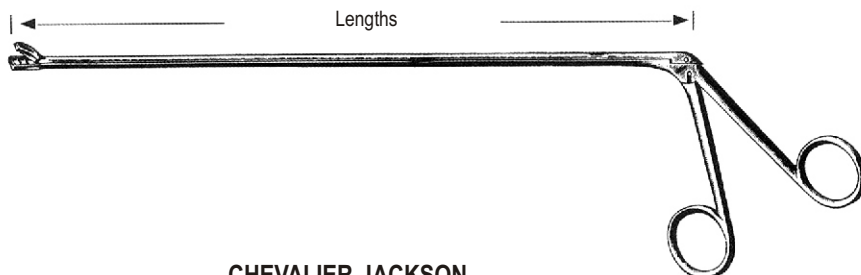

CHEVALIER-JACKSON



30.0cm	50.0331.30	50.0332.30	50.0333.30	50.0334.30	50.0335.30	50.0336.30	50.0337.30
40.0cm	50.0331.40	50.0332.40	50.0333.40	50.0334.40	50.0335.40	50.0336.40	50.0337.40
50.0cm	50.0331.50	50.0332.50	50.0333.50	50.0334.50	50.0335.50	50.0336.50	50.0337.50
60.0cm	50.0331.60	50.0332.60	50.0333.60	50.0334.60	50.0335.60	50.0336.60	50.0337.60



HUBER
50.0340.00



BRUENINGS (straight)

50.0344.20	20.0cm
50.0344.30	30.0cm
50.0344.40	40.0cm
50.0344.50	50.0cm
50.0344.60	60.0cm

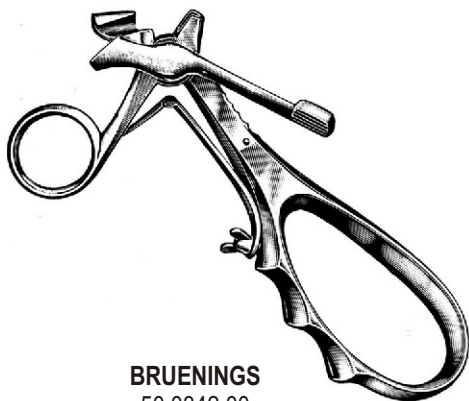

BRUENINGS
50.0342.00

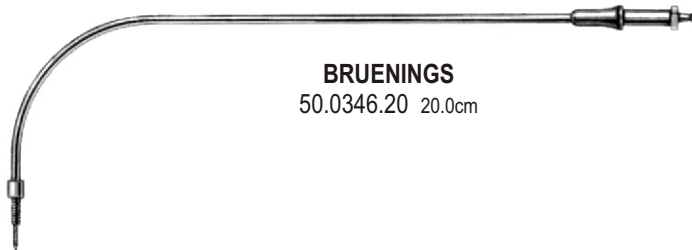

BRUENINGS

50.0346.20 20.0cm

50.0346.20

50-012

www.hilbro.net

TONSIL



FRAENKEL
50.0350.00



BARACANI
50.0354.00



SEIFFERT
50.0360.00



FRAENKEL
50.0364.00

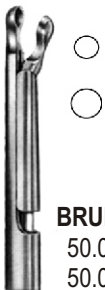

BRUENINGS
50.0370.01
50.0370.02

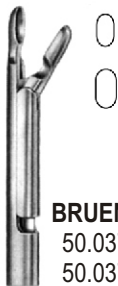

BRUENINGS
50.0374.01
50.0374.02



LANGE
50.0380.00



KRAUSE
50.0384.01
50.0384.02



SCHUMACHER
50.0390.00

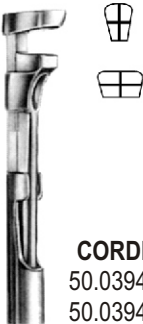

CORDES
50.0394.01
50.0394.02



CORDES
50.0400.00



ROSENBERG
50.0404.00



KRAUSE
50.0410.00

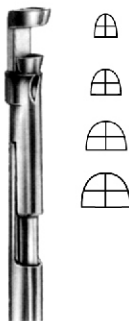

CORDES
50.0414.01
50.0414.02
50.0414.03
50.0414.04



SCHEINMANN
50.0420.00



SCHEINMANN
50.0424.00

50.0424.00

50-013

www.hilbro.net

EN Laryngeal Handles and Mirrors

DE Laryngeal Behandelt und Spiegelt wider

ES Los maneja y espejos laríngeos



TONSIL



50.0430.11



50.0434.10

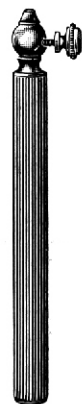

50.0440.11



50.0444.12



50.0450.00



MICHEL
25.0cm



50.0460.12



50.0460.14



50.0460.16

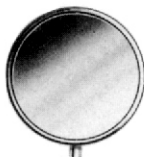

50.0460.18



50.0464.08
50.0464.10
50.0464.12
50.0464.14
50.0464.16
50.0464.18
50.0464.20
50.0464.22
50.0464.24
50.0464.26
50.0464.28
50.0464.30

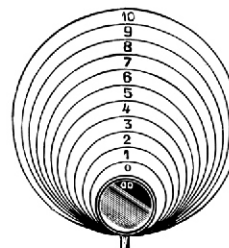

fig.00, 8mm Ø
fig.0, 10mm Ø
fig.1, 12mm Ø
fig.2, 14mm Ø
fig.3, 16mm Ø
fig.4, 18mm Ø
fig.5, 20mm Ø
fig.6, 22mm Ø
fig.7, 24mm Ø
fig.8, 26mm Ø
fig.9, 28mm Ø
fig.10, 30mm Ø



50.0466.08
50.0466.10
50.0466.12
50.0466.14
50.0466.16
50.0466.18
50.0466.20
50.0466.22
50.0466.24
50.0466.26
50.0466.28
50.0466.30

50.0466.30

50-014

www.hilbro.net

TONSIL



50.0470.01



50.0470.02



50.0470.03

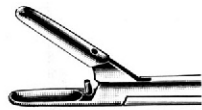

50.0470.04



JURASZ
23.0cm

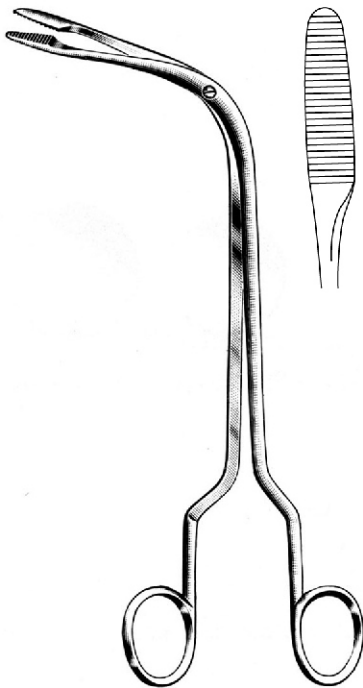

FRAENKEL
50.0474.19 19.0cm

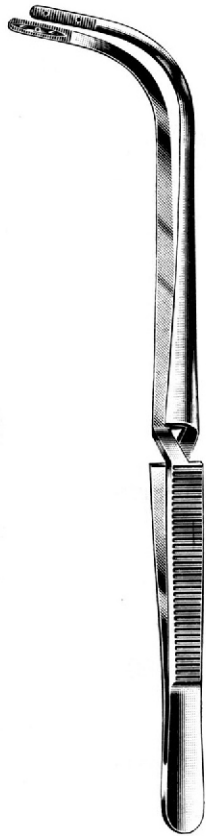

JACKSON
22.0cm



50.0480.22



50.0482.22



REICHERT
50.0486.24 24.0cm

50.0486.24

50-015

www.hilbro.net