

BONE SURGERY

28



PAGE 001 to 076



- EN Bone Surgery
- DE Kochenchirurgie
- ES Cirugía ósea

SERVING HEALTHCARE WORLDWIDE

www.hilbro.net



BONE SURGERY



28.0010.08 8mm
 28.0010.10 10mm
 28.0010.12 12mm
 28.0010.14 14mm
 28.0010.16 16mm
 13.5cm



28.0012.08 8mm
 28.0012.10 10mm
 28.0012.12 12mm
 28.0012.14 14mm
 28.0012.16 16mm
 13.5cm



28.0014.08 8mm
 28.0014.10 10mm
 28.0014.12 12mm
 28.0014.14 14mm
 28.0014.16 16mm
 13.5cm



PARTSCH
 13.5cm 17.0cm
 28.0020.02 2mm 28.0022.02
 28.0020.03 3mm 28.0022.03
 28.0020.04 4mm 28.0022.04
 28.0020.05 5mm 28.0022.05
 28.0020.06 6mm 28.0022.06



PARTSCH
 13.5cm 17.0cm
 28.0024.02 2mm 28.0026.02
 28.0024.03 3mm 28.0026.03
 28.0024.04 4mm 28.0026.04
 28.0024.05 5mm 28.0026.05
 28.0024.06 6mm 28.0026.06

28.0026.06

28-001

www.hilbro.net

EN Bone Chisels and Gouges

DE Meissel und Osteotome

ES Cinceles y gubias para huesos



BONE SURGERY

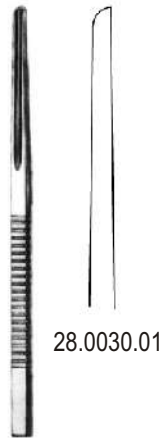

28.0030.01

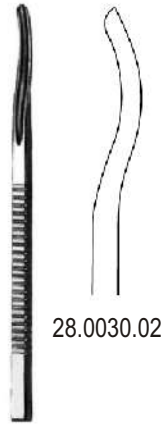

28.0030.02

BUCK-GRAMCKO
11.0cm



28.0032.01

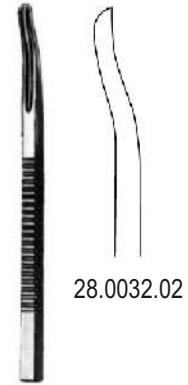

28.0032.02

BUCK-GRAMCKO
10.0cm

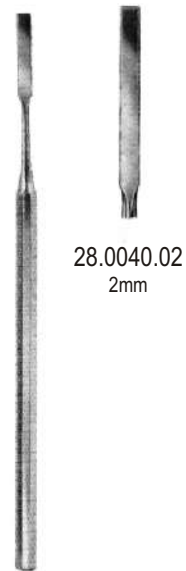

28.0040.02
2mm



28.0040.03
3mm



28.0040.04
4mm

BUCKLEY
16.0cm

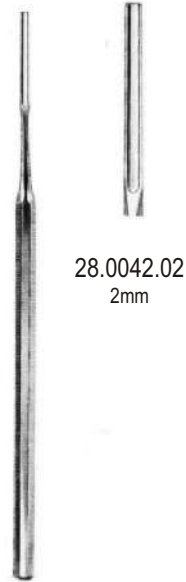

28.0042.02
2mm



28.0042.03
3mm



28.0042.04
4mm

BUCKLEY
16.0cm

28.0042.04

28-002

www.hilbro.net

BONE SURGERY

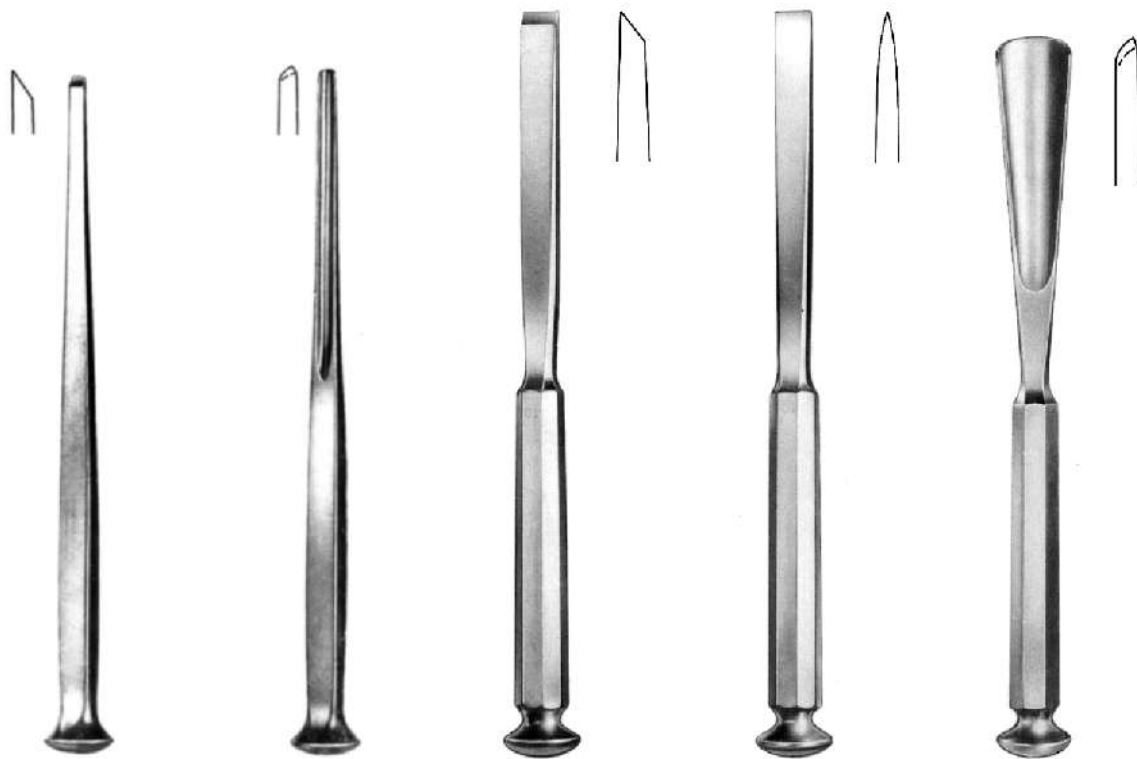

ALEXANDER

18.0cm

- 28.0046.04 04mm
- 28.0046.06 06mm
- 28.0046.08 08mm
- 28.0046.10 10mm
- 28.0046.12 12mm
- 28.0046.14 14mm

ALEXANDER

18.0cm

- 28.0048.04 04mm
- 28.0048.06 06mm
- 28.0048.08 08mm
- 28.0048.10 10mm
- 28.0048.12 12mm
- 28.0048.14 14mm

STILLE

20.0cm

- 28.0050.10 10mm
- 28.0050.15 15mm
- 28.0050.20 20mm
- 28.0050.25 25mm

STILLE

20.0cm

- 28.0052.10 10mm
- 28.0052.15 15mm
- 28.0052.20 20mm
- 28.0052.25 25mm

STILLE

20.0cm

- 28.0054.10 10mm
- 28.0054.15 15mm
- 28.0054.20 20mm
- 28.0054.25 25mm

28.0054.25

28-003

www.hilbro.net

EN Bone Chisels and Gouges

DE Meissel und Osteotome

ES Cineles y gubias para huesos



BONE SURGERY



- 28.0060.06 6mm
- 28.0060.09 9mm
- 28.0060.13 13mm
- 28.0060.16 16mm
- 28.0060.19 19mm
- 28.0060.25 25mm
- 28.0060.32 32mm

SMITH-PETERSEN
20.0cm



- 28.0061.06 6mm
- 28.0061.09 9mm
- 28.0061.13 13mm
- 28.0061.16 16mm
- 28.0061.19 19mm
- 28.0061.25 25mm
- 28.0061.32 32mm

SMITH-PETERSEN
20.0cm



- 28.0064.06 6mm
- 28.0064.09 9mm
- 28.0064.13 13mm
- 28.0064.16 16mm
- 28.0064.19 19mm
- 28.0064.25 25mm
- 28.0064.32 32mm

SMITH-PETERSEN
20.0cm

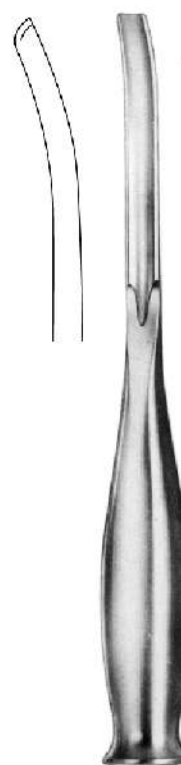

- 28.0065.06 6mm
- 28.0065.09 9mm
- 28.0065.13 13mm
- 28.0065.16 16mm
- 28.0065.19 19mm
- 28.0065.25 25mm
- 28.0065.32 32mm

SMITH-PETERSEN
20.0cm

28.0065.32

28-004

www.hilbro.net

BONE SURGERY



- 28.0070.03 3mm
- 28.0070.05 5mm
- 28.0070.06 6mm
- 28.0070.08 8mm
- 28.0070.09 9mm

HOKE
17.0cm



- 28.0080.06 6mm
- 28.0080.13 13mm
- 28.0080.19 19mm
- 28.0080.25 25mm
- 28.0080.32 32mm

HIBBS
24.0cm



- 28.0084.06 6mm
- 28.0084.13 13mm
- 28.0084.19 19mm
- 28.0084.25 25mm
- 28.0084.32 32mm

HIBBS
24.0cm



- 28.0081.06 6mm
- 28.0081.13 13mm
- 28.0081.19 19mm
- 28.0081.25 25mm
- 28.0081.32 32mm

HIBBS
24.0cm



- 28.0086.06 6mm
- 28.0086.13 13mm
- 28.0086.19 19mm
- 28.0086.25 25mm
- 28.0086.32 32mm

HIBBS
24.0cm



- 28.0087.06 6mm
- 28.0087.13 13mm
- 28.0087.19 19mm
- 28.0087.25 25mm
- 28.0087.32 32mm

HIBBS
24.0cm

28.0087.32

28-005

www.hilbro.net

EN Bone Chisels and Gouges

DE Meissel und Osteotome

ES Cineles y gubias para huesos



BONE SURGERY



- 28.0090.03 3mm
- 28.0090.04 4mm
- 28.0090.06 6mm
- 28.0090.08 8mm
- 28.0090.10 10mm
- 28.0090.12 12mm
- 28.0090.15 15mm

MINI-LAMBOTTE
12.5cm



- 28.0092.03 3mm
- 28.0092.04 4mm
- 28.0092.06 6mm
- 28.0092.08 8mm
- 28.0092.10 10mm
- 28.0092.12 12mm
- 28.0092.15 15mm

MINI-LAMBOTTE
17.0cm



- 28.0094.15 15mm
- 28.0094.20 20mm
- 28.0094.25 25mm
- 28.0094.30 30mm
- 28.0094.38 38mm
- 28.0094.44 44mm
- 28.0094.50 50mm

LAMBOTTE
24.0cm



- 28.0095.15 15mm
- 28.0095.20 20mm
- 28.0095.25 25mm
- 28.0095.30 30mm
- 28.0095.38 38mm
- 28.0095.44 44mm
- 28.0095.50 50mm

LAMBOTTE
23.0cm

28.0095.50

28-006

www.hilbro.net

BONE SURGERY



- 28.0100.04 4mm
- 28.0100.06 6mm
- 28.0100.08 8mm
- 28.0100.10 10mm
- 28.0100.12 12mm

MINI-LEXER
18.0cm



- 28.0102.04 4mm
- 28.0102.06 6mm
- 28.0102.08 8mm
- 28.0102.10 10mm
- 28.0102.12 12mm

MINI-LEXER
18.0cm



- 28.0104.07 7mm
- 28.0104.10 10mm
- 28.0104.15 15mm
- 28.0104.20 20mm
- 28.0104.25 25mm
- 28.0104.30 30mm

LEXER
22.0cm



- 28.0106.07 7mm
- 28.0106.10 10mm
- 28.0106.15 15mm
- 28.0106.20 20mm
- 28.0106.25 25mm
- 28.0106.30 30mm

LEXER
22.0cm

28.0106.30

28-007

www.hilbro.net

EN Bone Chisels and Gouges

DE Meissel und Osteotome

ES Cinceles y gubias para huesos



BONE SURGERY



28.0110.05 5mm
28.0110.10 10mm
28.0110.15 15mm

LEXER
25.0cm



28.0111.05 5mm
28.0111.10 10mm
28.0111.15 15mm

LEXER
25.0cm

28.0111.15

28-008

www.hilbro.net

Mallets EN

Hammer DE

Martillos y mazos ES

28

BONE SURGERY



MEAD
28.0120.17 17.0cm
26mm Ø,320 g (11¼ oz)



PARTSCH
28.0124.18 18.0cm
22mm Ø,200 g (7 oz)

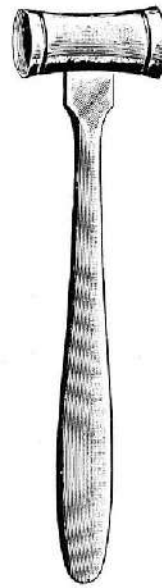

28.0130.30
30mm Ø,510 g

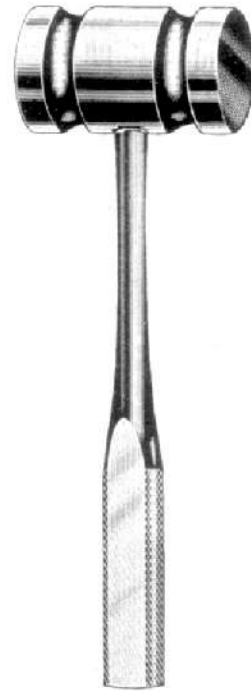

28.0134.25 250 g
28.0134.45 450 g
28.0134.90 900 g
26.5cm

28.0134.90

28-009

www.hilbro.net

EN **Mallets**

DE **Hämmer**

ES **Martillos y mazos**



BONE SURGERY

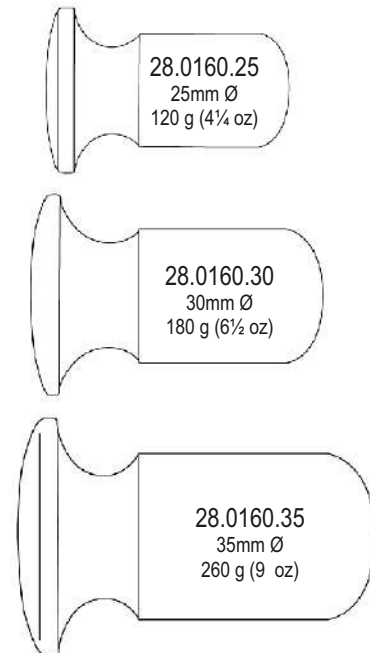
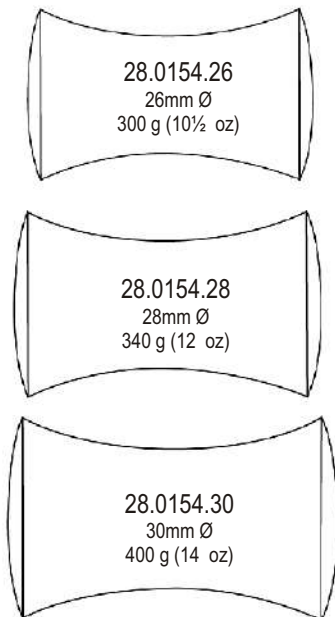
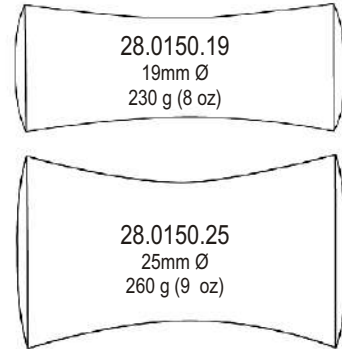

28.0160.35

28-010

www.hilbro.net

Mallets EN

Hammer DE

Martillos y mazos ES

28

BONE SURGERY

Hilbro

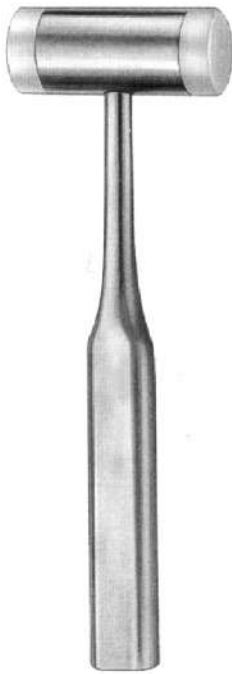

28.0164.18 18.5cm
25mm Ø 135 g

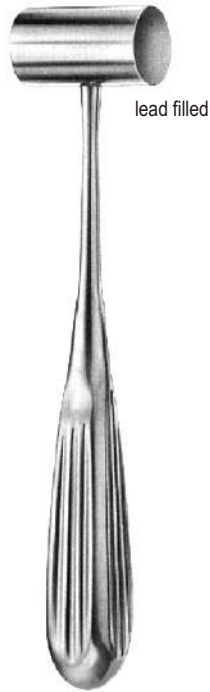

28.0170.19 19.0cm
22mm Ø 155 g



HAJEK
28.0174.22 22.0cm
27mm Ø 130 g



GERZOG
28.0180.18 18.0cm
250 g

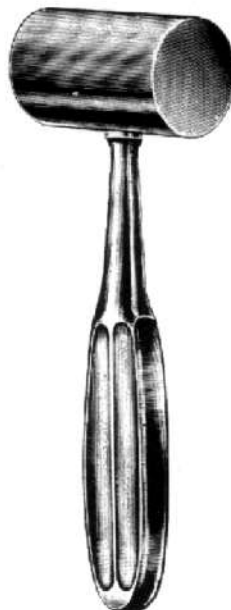

KIRK
28.0184.19 19.0cm
750 g

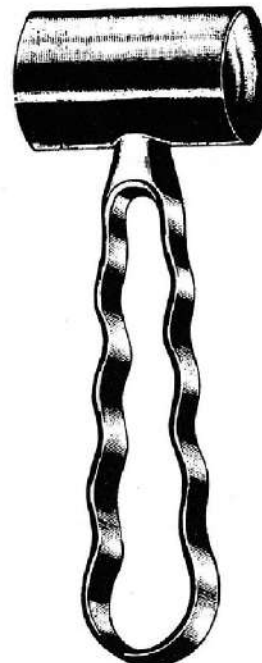

HEATH
18.0cm
28.0188.35 35mm Ø (28 oz)
28.0188.40 40mm Ø (36 oz)

28.0188.40

28-011

www.hilbro.net

28

EN Mallets

DE Hämmer

ES Martillos y mazos

Hilbro

BONE SURGERY

28.0200.00
spare faces



42mm Ø 30mm Ø



28.0190.26
26.5cm 530 g (19 oz)



28.0194.24
24.0cm (30mm Ø 480 g)

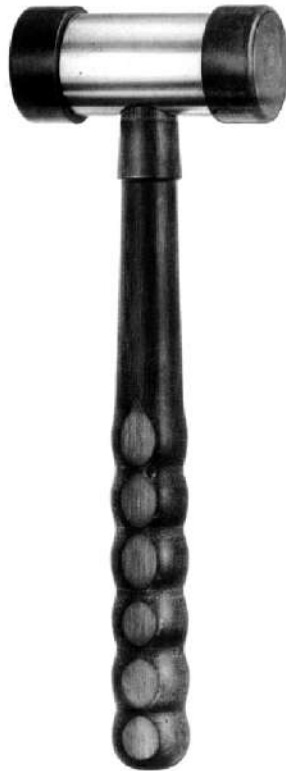

28.0200.22
22.5cm (37mm Ø 370 g)



28.0204.24 24.0cm

28.0204.24

28-012

www.hilbro.net

Mallets EN

Hammer DE

Martillos y mazos ES

28

BONE SURGERY

Hilbro



28.0210.26 26.5cm
30mm Ø, 510 g (18 oz)



28.0214.26 26.5cm



28.0220.25 26.5cm 250 g (0.55 lbs)
28.0220.45 26.5cm 450 g (1 lbs)
28.0220.90 26.5cm 900 g (2 lbs)

28.0220.90

28-013

www.hilbro.net

EN Bone Currettes

DE Scharfe Löffel

ES Cucharilla cortantes



BONE SURGERY

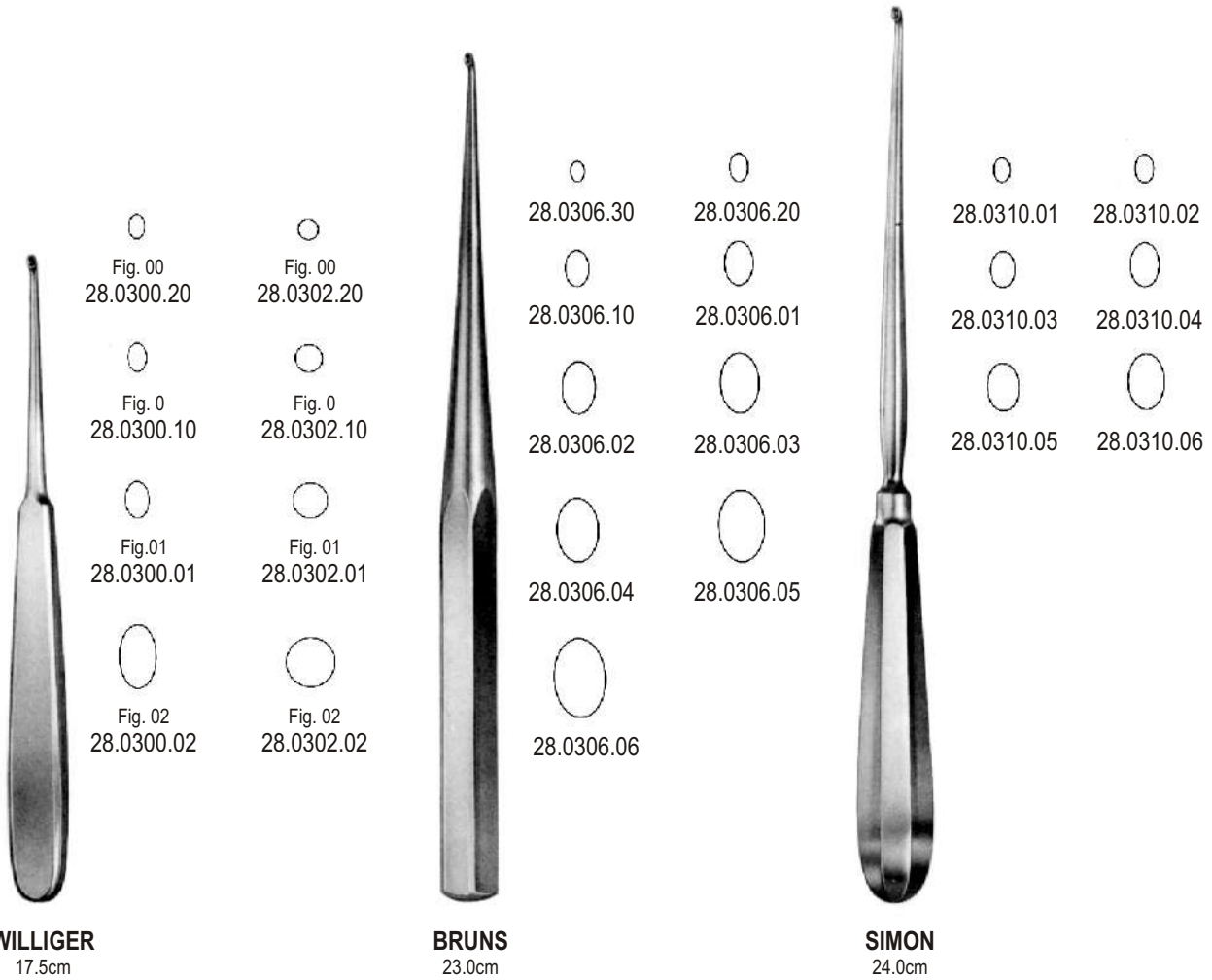

28.0310.06

28-014

www.hilbro.net

BONE SURGERY



MOD. USA
16.0cm

Fig.1

Fig.2

Fig.03

Fig.04

Fig.05

Fig.06

Fig.1 28.0320.01
 Fig.2 28.0320.02
 Fig.3 28.0320.03
 Fig.4 28.0320.04
 Fig.5 28.0320.05
 Fig.6 28.0320.06

28.0322.01
 28.0322.02
 28.0322.03
 28.0322.04
 28.0322.05
 28.0322.06

28.0324.01
 28.0324.02
 28.0324.03
 28.0324.04
 28.0324.05
 28.0324.06



LEMPERT
17.5cm

Fig.0

Fig.00

Fig.000

Fig.0000

Fig.00000

Fig.0 28.0330.10
 Fig.00 28.0330.20
 Fig.000 28.0330.30
 Fig.0000 28.0330.40
 Fig.00000 28.0330.50



HALLE
21.0cm

28.0334.01

28.0334.02

28.0334.03



25.0cm

28.0340.01

28.0340.02

28.0340.03

28.0340.03

28-015

www.hilbro.net

EN Bone Curettes

DE Scharfe Löffel











ES Cucharilla cortantes



BONE SURGERY













VOLKMANN
17.0cm

 0000 28.0344.40	 000 28.0344.30	 00 28.0344.20
 0 28.0344.10	 1 28.0344.01	 2 28.0344.02
	 3 28.0344.03	 4 28.0344.04
	 5 28.0344.05	 6 28.0344.06









BRUNS
17.0cm

 0000 28.0350.40	 000 28.0350.30	 00 28.0350.20
 0 28.0350.10	 1 28.0350.01	 2 28.0350.02
	 3 28.0350.03	 4 28.0350.04
	 5 28.0350.05	 6 28.0350.06











SCHEDE
17.0cm

 000 28.0354.30	 00 28.0354.20	 0 28.0354.10
	 1 28.0354.01	 2 28.0354.02
	 3 28.0354.03	 4 28.0354.04



SPRATT
16.5cm

 0000 28.0360.40	 000 28.0360.30	 00 28.0360.20
 0 28.0360.10		 1 28.0360.01
 2 28.0360.02		 3 28.0360.03
 4 28.0360.04		 5 28.0360.05

28.0360.05

28-016

www.hilbro.net

Bone Curettes EN

Scharfe Löffel DE

Cucharilla cortantes ES

28

BONE SURGERY

Hilbro

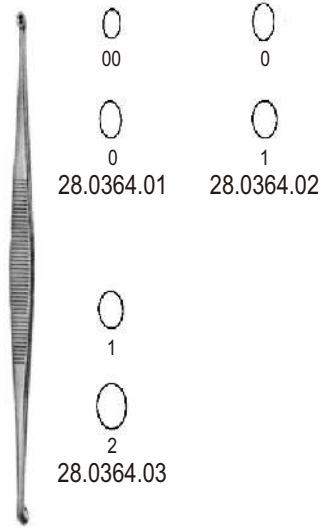

WILLIGER
13.5cm

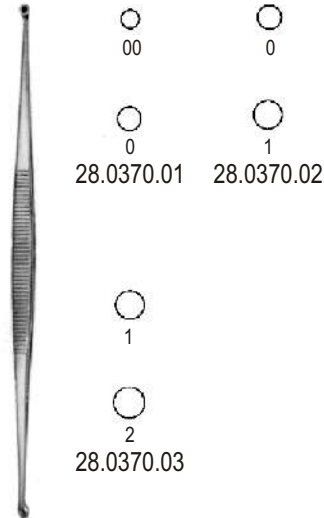

MARTINI
13.5cm



VOLKMANN
28.0374.13 13.0cm
28.0374.14 14.0cm
28.0374.17 17.0cm



VOLKMANN
28.0380.13 13.0cm
28.0380.16 16.0cm
28.0380.20 20.0cm



28.0384.21 21.0cm

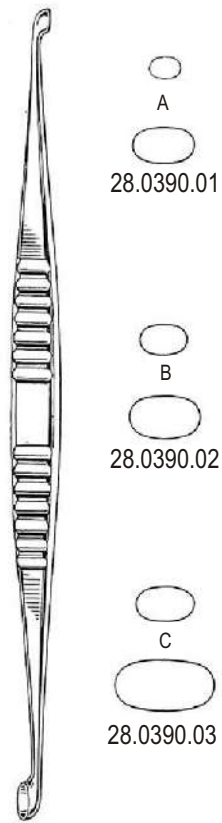

VOLKMANN
21.5cm

28.0390.03

28-017

www.hilbro.net

EN Bone Curettes

DE Scharfe Löffel

ES Cucharilla cortantes



BONE SURGERY



VOLKMANN
17.0cm

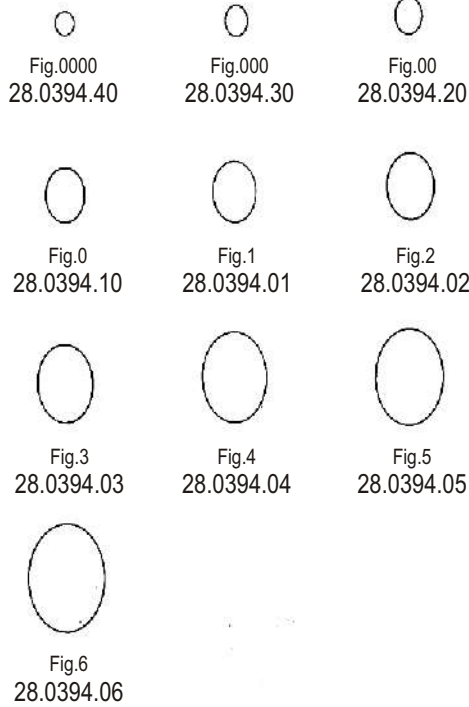

VOLKMANN
27.0cm

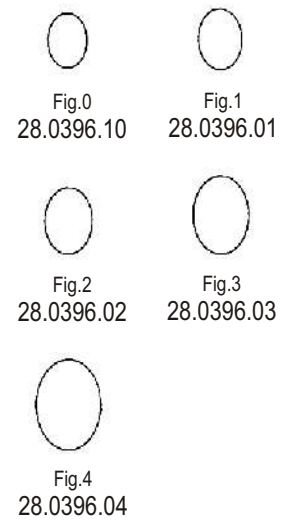

28.0396.04

28-018

www.hilbro.net

Bone Files EN

Knochenfeile DE

Lima para huesos ES

28

BONE SURGERY

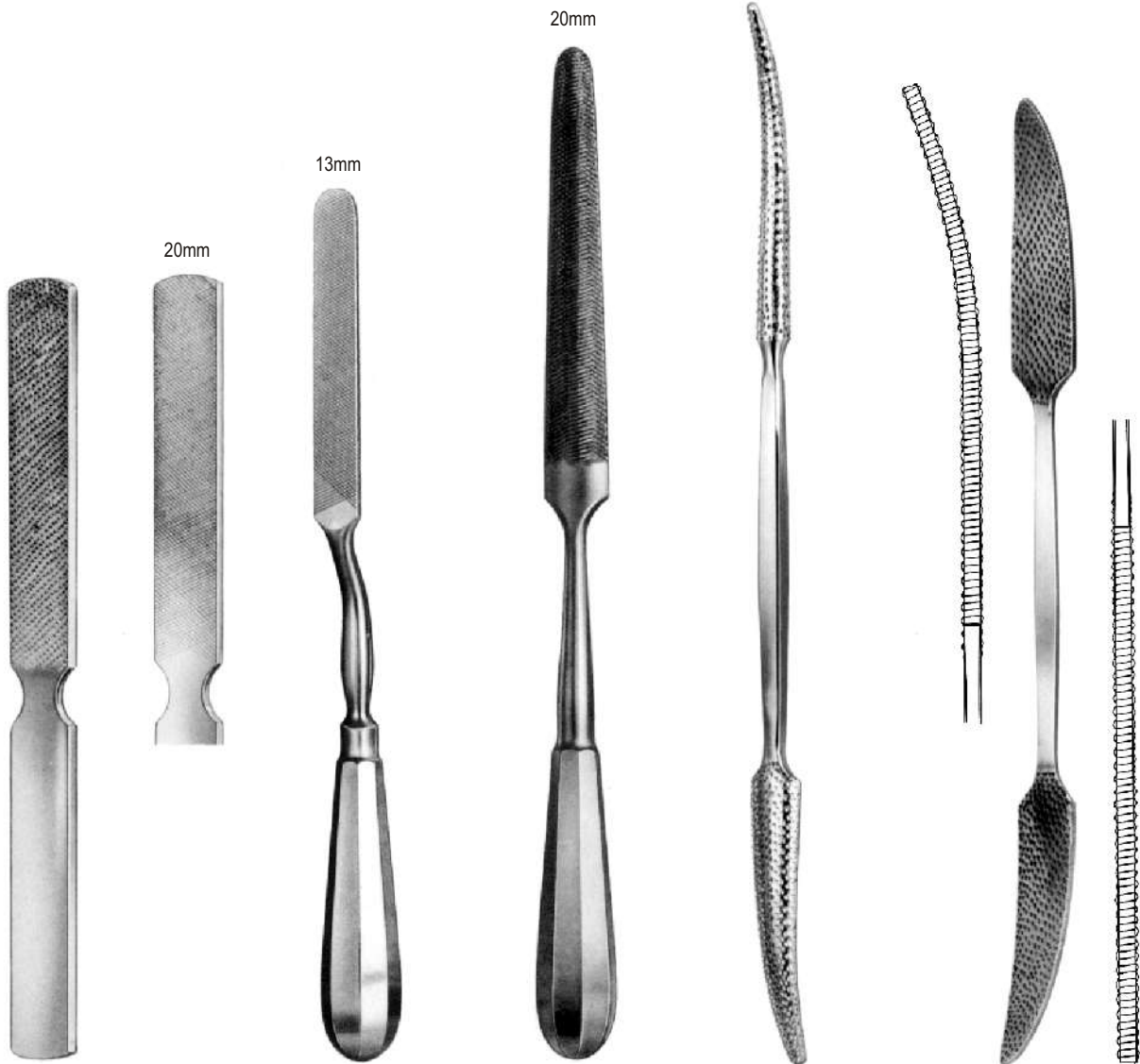

28.0400.22 22.0cm

28.0404.24 24.5cm

28.0410.28 28.0cm

PUTTI
28.0414.30 30.0cm

PUTTI
28.0416.27 27.0cm

28.0416.27

28-019

www.hilbro.net

EN Bone Files

DE Knochenfeile

ES Lima para huesos



BONE SURGERY



MILLER
10
28.0450.10



MILLER
11
28.0450.11

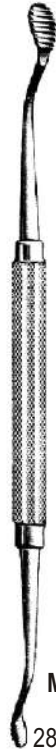

MILLER
12
28.0450.12



MILLER
13
28.0450.13



MILLER
14
28.0450.14



MILLER
10c
28.0452.10



MILLER
11c
28.0452.11



MILLER
12c
28.0452.12



MILLER
13c
28.0452.13



FOMON
21.5cm
28.0460.21



FOMON
21.5cm
28.0462.21

28.0462.21

28-020

www.hilbro.net

Periosteal Raspatories EN

Raspatorien DE

Legras periostotomos ES

28

BONE SURGERY



SEMB

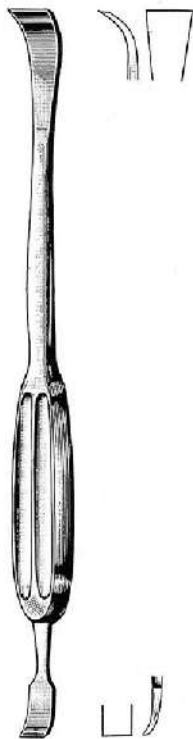

DAVIDSON-ALEXANDER
28.0474.29 29.0cm

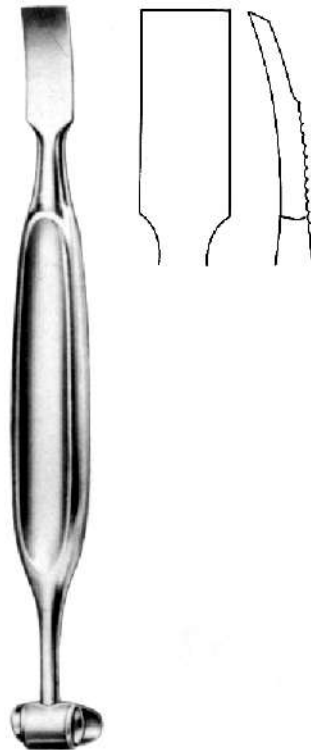

ALEXANDER
28.0480.20 20.0cm

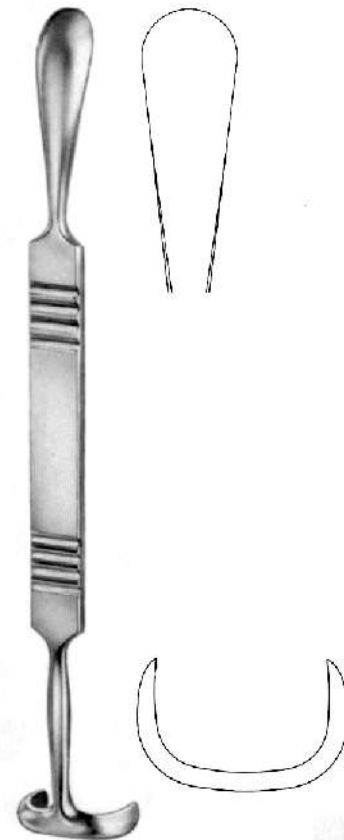

MATSON
28.0484.22 22.0cm

28.0484.22

28-021

www.hilbro.net

EN Periosteal Raspatories

DE Raspatorien

ES Legras periostotomos



BONE SURGERY

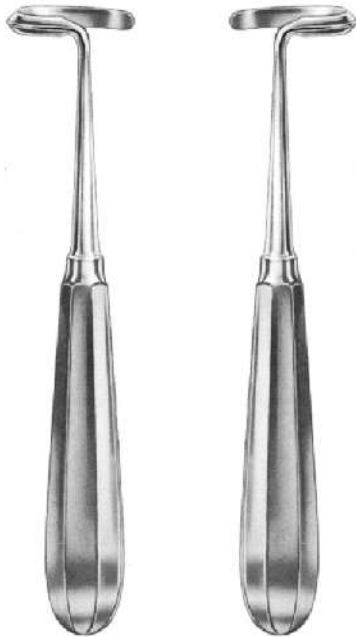

DOYEN
17.0cm

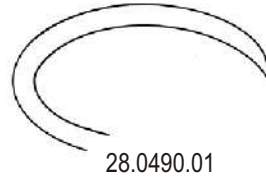

28.0490.01

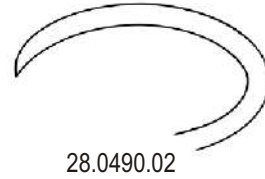

28.0490.02

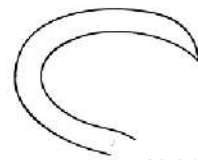

28.0492.01

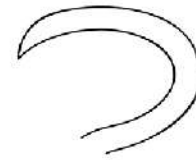

28.0492.02

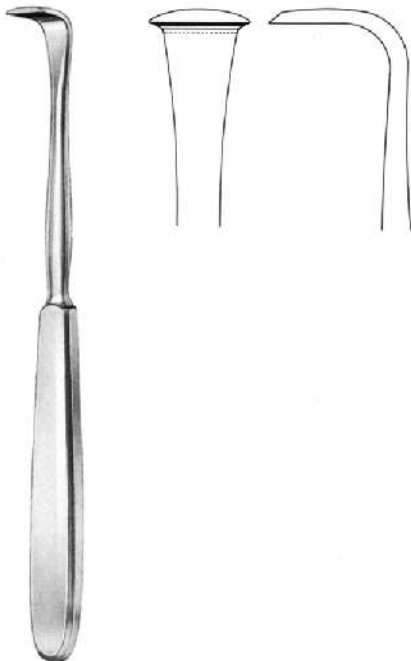

LANGENBECK
28.0500.18 18.0cm



LANGENBECK
28.0502.19 19.0cm



LAMBOTTE
21.0cm

- 28.0506.10 10mm
- 28.0506.15 15mm
- 28.0506.20 20mm
- 28.0506.25 25mm

28.0506.25

28-022

www.hilbro.net

BONE SURGERY

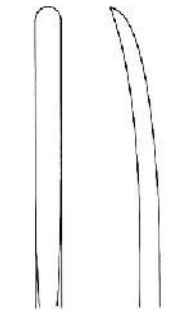

28.0510.04 4mm
28.0510.06 6mm

CUSHING
17.0cm

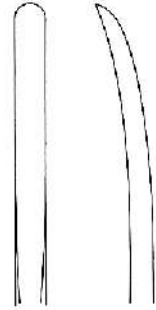

28.0512.05 5mm
28.0512.07 7mm

CUSHING
19.5cm

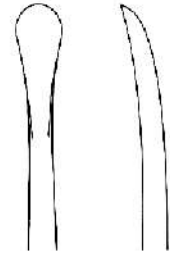

28.0516.07 7mm, 16.0cm
28.0516.15 15mm, 18.5cm
28.0516.20 20mm, 19.0cm

HOEN



8mm

CUSHING
28.0520.17
17.0cm



28.0524.01
19.0cm, 16mm

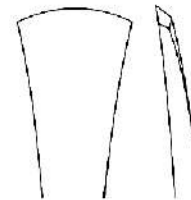

28.0524.02
19.0cm, 16mm

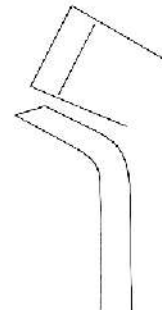

28.0524.03
19.0cm, 12mm

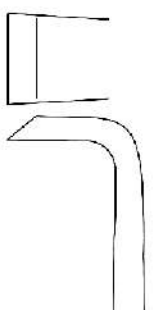

28.0524.04
18.0cm, 12mm

LANGENBECK

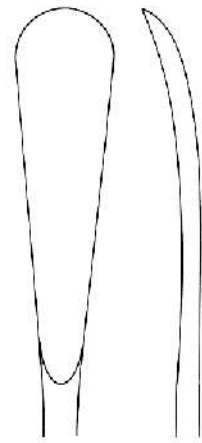

SEDILLOT
28.0530.21
21.0cm

28.0530.21

28-023

www.hilbro.net

EN Periosteal Raspatories

DE Raspatorien

ES Legras periostotomos



BONE SURGERY

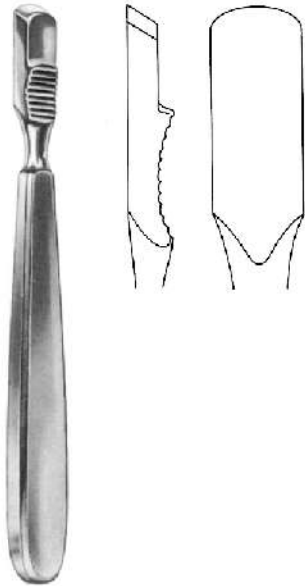

FARABEU
28.0534.15 15.0cm

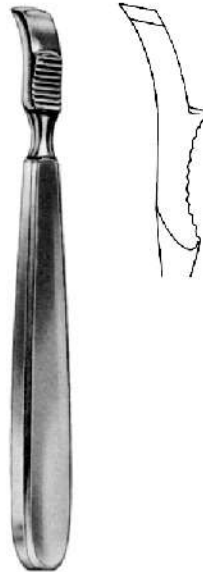

FARABEU
28.0535.15 15.0cm



17.0cm

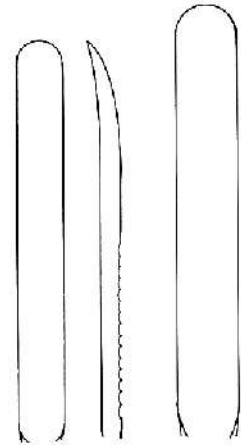

28.0540.06
6mm

28.0540.08
8mm



WILLIGER
28.0544.13 13.0cm

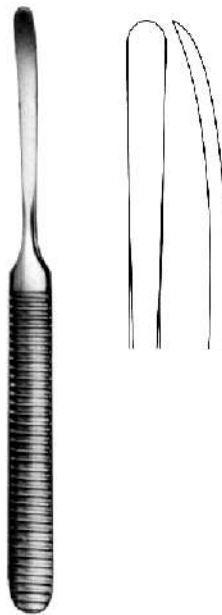

WILLIGER
28.0546.16 16.0cm



28.0550.05
5mm



28.0550.06
6mm



28.0550.07
7mm

28.0550.07

28-024

www.hilbro.net

Periosteal Raspatories EN

Raspatorien DE

Legras periostotomos ES

28

BONE SURGERY

Hilbro

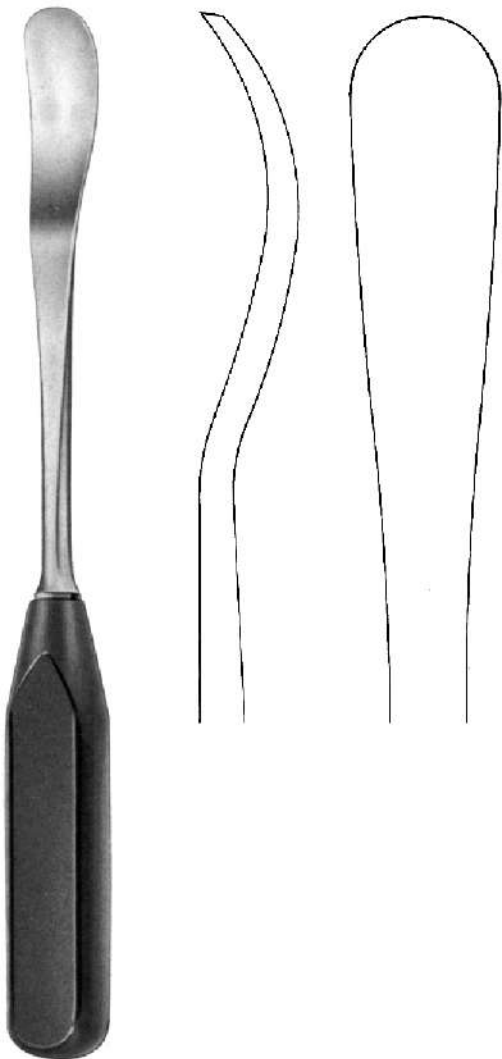

28.0554.27 27.5cm
20mm

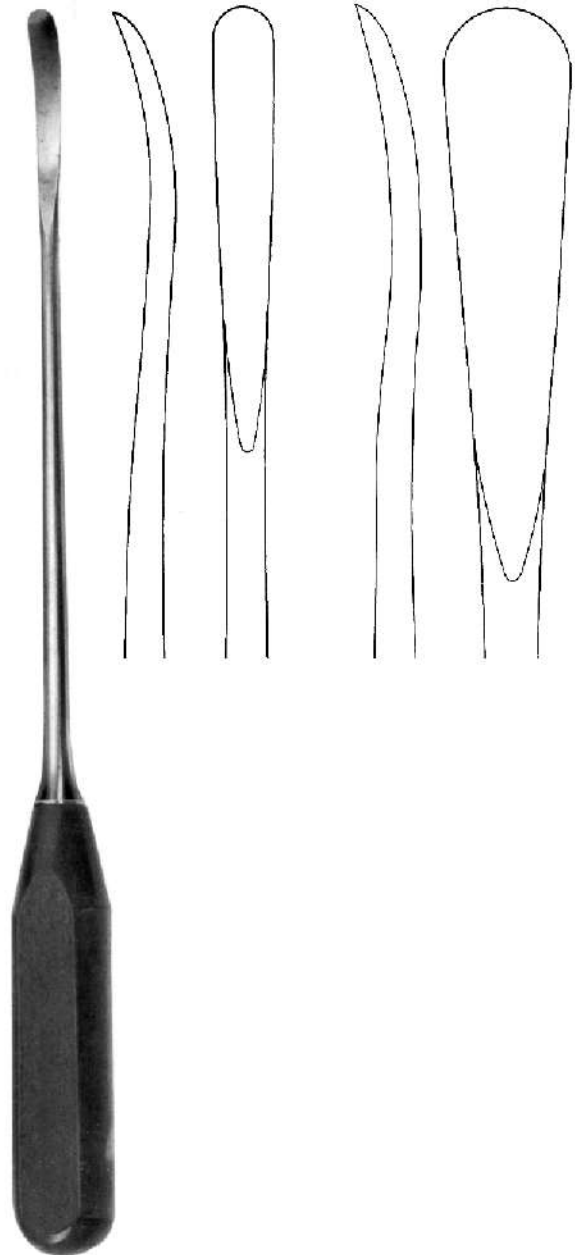

WAGNER
33.0cm
28.0560.08 8mm
28.0560.17 17mm

28.0560.17

28-025

www.hilbro.net

EN Periosteal Raspatories

DE Raspatorien

ES Legras periostotomos

Hilbro

BONE SURGERY



28.0564.18 18.0cm



28.0570.18 18.0cm



28.0572.18 18.0cm



28.0574.19 19.0cm

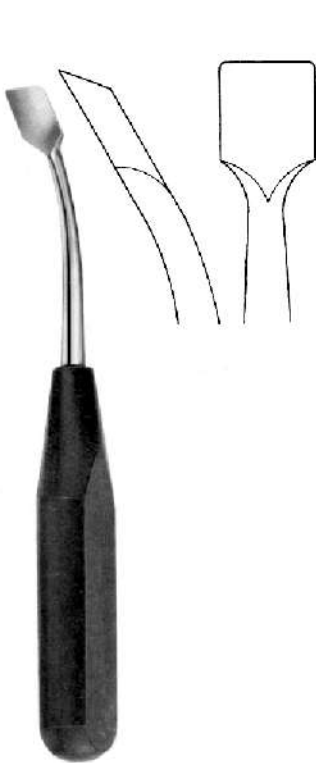

28.0576.18 18.5cm



28.0580.20 20.0cm



28.0581.20 20.0cm

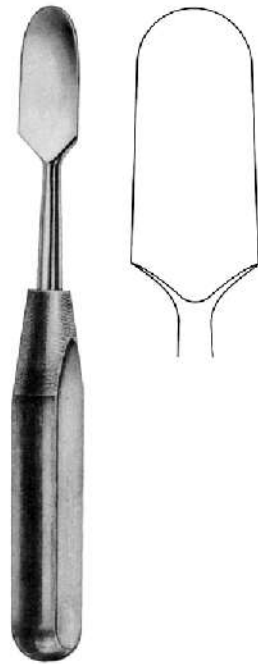

28.0584.20 20.0cm

28.0584.20

28-026

www.hilbro.net

Periosteal Raspatories EN

Raspatorien DE

Legras periostotomos ES

28

BONE SURGERY



COBB

24.0cm		28.0cm	
28.0590.10	10mm	28.0592.10	10mm
28.0590.13	13mm	28.0592.13	13mm
28.0590.19	19mm	28.0592.19	19mm
28.0590.25	25mm	28.0592.25	25mm
28.0590.32	32mm	28.0592.32	32mm

COBB

27.0cm	
28.0594.04	4mm
28.0594.06	6mm
28.0594.08	8mm

COBB

28.0cm	
28.0596.08	8mm
28.0596.10	10mm
28.0596.12	12mm

28.0596.12

28-027

www.hilbro.net

EN Elevators

DE Elevatorien

ES Elevadores

Hilbro

BONE SURGERY



28.0600.16 16.0cm



28.0604.17 17.5cm



28.0610.06 6mm
28.0610.12 12mm
28.0610.19 19mm
28.0610.25 25mm

KEY
19.0cm

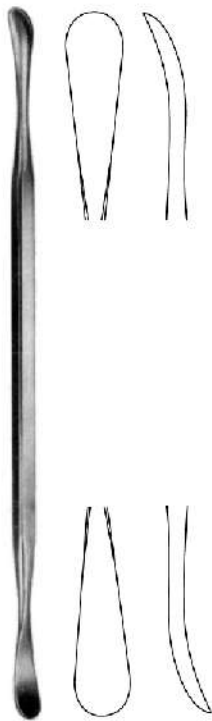

ALDERDYCE
28.0614.21 21.0cm



OVERHOLT
28.0620.29 29.5cm



OVERHOLT
28.0622.29 29.5cm

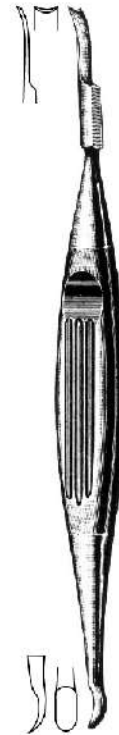

OVERHOLT
28.0624.28 28.5cm

28.0624.28

28-028

www.hilbro.net

Elevators EN

Elevatoren DE

Elevadores ES

28

BONE SURGERY



LANGENBECK
20.0cm
28.0630.08 8mm
28.0630.10 10mm



LANGENBECK



28.0632.05
17.0cm, 5mm



28.0632.07
17.0cm, 7mm



28.0632.08
20.0cm, 8mm



28.0632.10
20.0cm, 10mm



ST. THOMAS
28.0636.18 18.0cm



ADSON
17.0cm

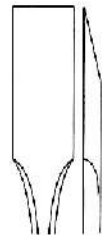

28.0640.01



28.0640.02



28.0640.03



28.0640.04



WILLIGER
17.0cm



28.0644.17



WILLIGER
16.0cm



28.0646.16



28.0648.16
16.0cm

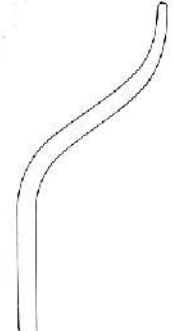

28.0648.16

28-029

www.hilbro.net

28

EN Bone Levers

DE Knochenhebel

ES Elevadores para huesos

Hilbro

BONE SURGERY



LANE
28.0650.26 26.5cm



LANE TRETOWAN
28.0652.21 21.5cm



LANE
28.0654.25 25.5cm



BRISTOW
28.0660.23 23.0cm



MURPHY-LANE
28.0664.34 34.0cm

28.0664.34

28-030

www.hilbro.net

Bone Levers EN

Knochenhebel DE

Elevadores para huesos ES

28

BONE SURGERY

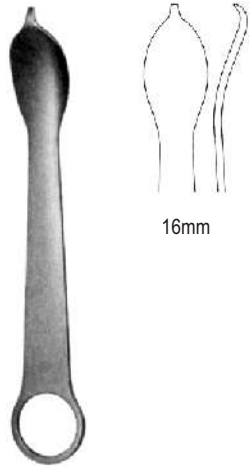

16mm

28.0670.12 12.0cm

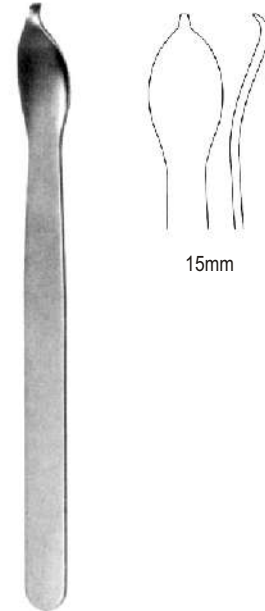

15mm

28.0674.16 16.0cm

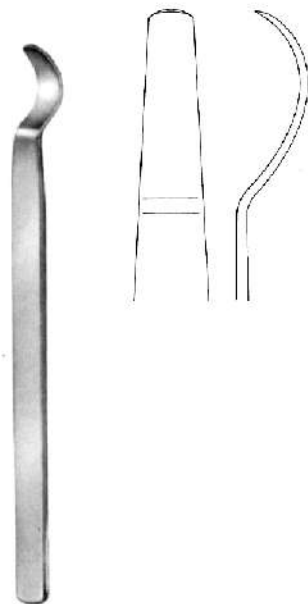

28.0680.14 14.0cm

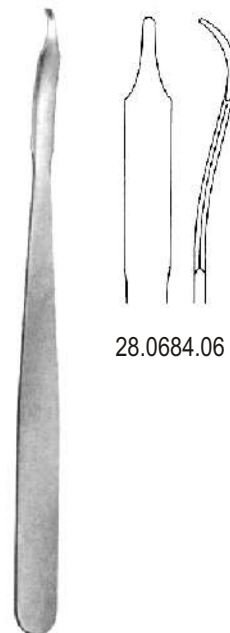

28.0684.06

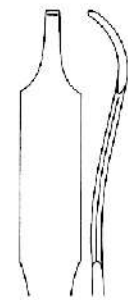

28.0684.08

MINI-HOHMANN

16.0cm

28.0684.08

28-031

www.hilbro.net

28

EN Bone Levers

DE Knochenhebel

ES Elevadores para huesos

Hilbro

BONE SURGERY



HOHMANN
28.0690.08 8mm

HOHMANN
28.0690.18 18mm

HOHMANN
28.0690.43 43mm

HOHMANN
28.0690.70 70mm

28.0690.70

28-032

www.hilbro.net

Bone Levers EN

Knochenhebel DE

Elevadores para huesos ES

28

BONE SURGERY



HOHMANN
28.0692.43 43mm

HOHMANN
28.0694.22 22mm

HOHMANN
28.0694.33 33mm

HOHMANN
28.0696.24 24mm

LANGE-HOHMANN
28.0698.22 22mm

28.0698.22

28-033

www.hilbro.net

EN Bone Levers

DE Knochenhebel

ES Elevadores para huesos



BONE SURGERY



LANGE-HOHMANN
28.0700.27 27.0cm
28.0700.29 29.0cm



LANGE-HOHMANN
28.0702.27 27.0cm
28.0702.29 29.0cm



BENNETT
28.0710.24 24.0cm
28.0710.26 26.0cm



BENNETT
28.0712.24 24.0cm
28.0712.26 26.0cm



BLOUNT
28.0720.26 26.0cm



BLOUNT
28.0722.26 26.0cm



BLOUNT
28.0724.17 17.5cm



TAYLOR
16.5cm
28.0730.75 75x30mm
28.0730.10 100x30mm

28.0730.10

28-034

www.hilbro.net

Retractors EN

Wundhaken DE

Separadores ES

28

BONE SURGERY



SMILLIE
14.0cm



28.0734.01
32x19mm



28.0734.02
48x19mm



28.0734.03
57x19mm



28.0734.04
52x13mm



28.0734.05
12x13mm



28.0740.17
17.0cm, 56x10mm



28.0744.22
22.0cm, 38x9mm

28.0744.22

28-035

www.hilbro.net

EN Meniscotomy Knives

DE Meniskotome

ES Bisturios para meniscos



BONE SURGERY



SMILLIE
17.0cm



MOD. SCHWEDEN
17.0cm



BIRCHER
19.0cm



28.0760.02

28-036

www.hilbro.net

Meniscotomy Knives EN

Meniskotome DE

Bisturios para meniscos ES

28

BONE SURGERY



28.0764.18
18.0cm



28.0770.01



28.0770.02

NEFF
22.0cm



SALENIUS
28.0774.01 22.0cm



SALENIUS
28.0774.02 22.0cm



LOWE-BRECK
28.0780.25 25.0cm



DOWNING
28.0784.25 25.0cm

28.0784.25

28-037

www.hilbro.net

EN Sequestrum and Cartilage seizing Forceps

DE Sequester und knorpelfasszangen

ES Pinzas para secuestros y cartilago

Hilbro

BONE SURGERY

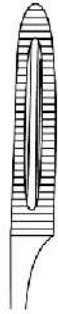

28.0800.20
20.0cm



28.0801.20
20.0cm

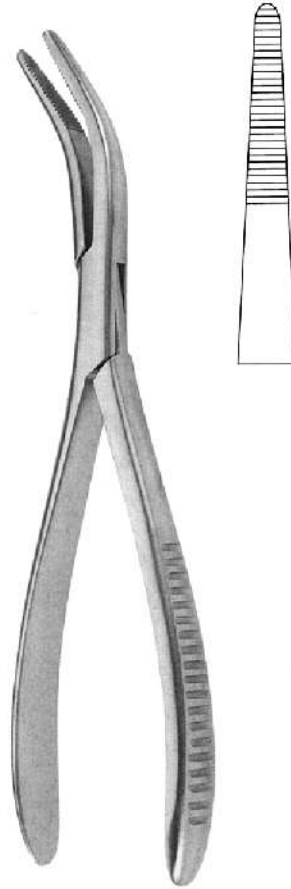

VAN BUREN
28.0806.23
23.0cm

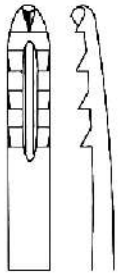

28.0810.20

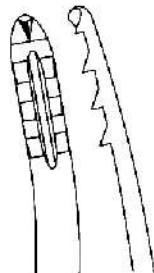

28.0811.20

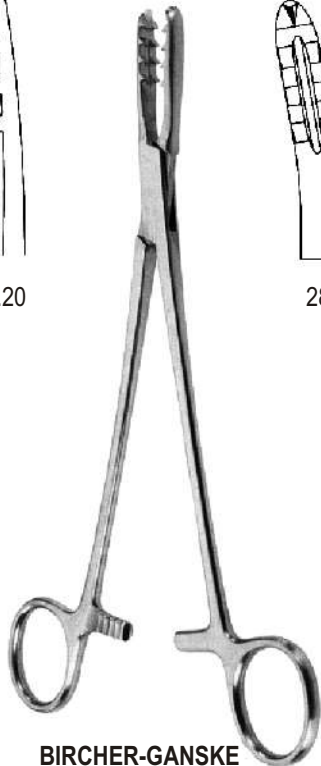

BIRCHER-GANSKE
20.0cm

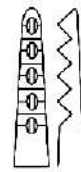

28.0816.19



MARTIN
19.0cm

28.0816.19

28-038

www.hilbro.net

Bone Holding Forceps EN

Knochenhaltezangen DE

Pinzas para huesos ES

28

BONE SURGERY

Hilbro

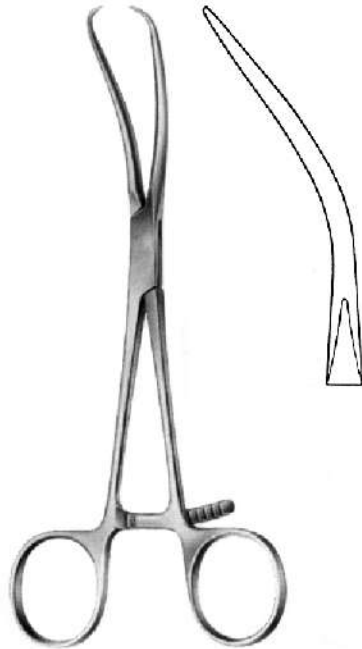

REILL
28.0820.17 17.0cm

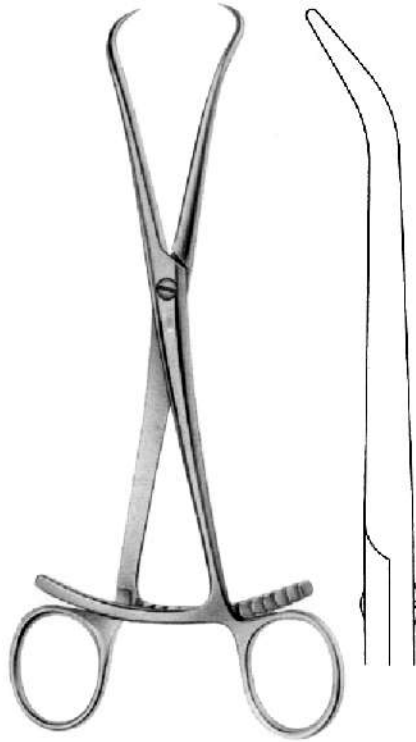

28.0824.20 20.5cm

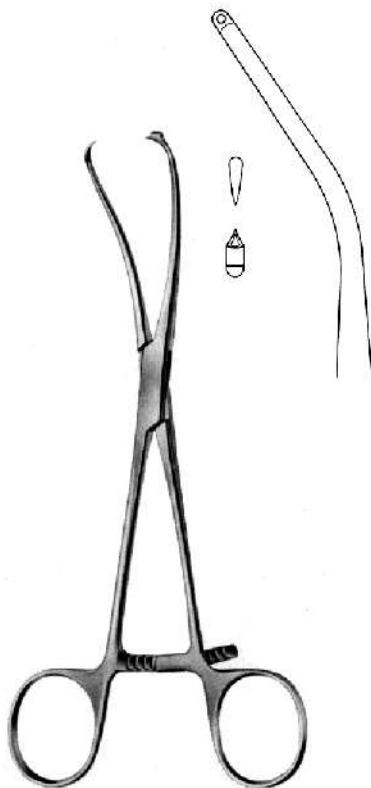

MEYER
28.0830.17 17.0cm



28.0834.21 21.0cm

28.0834.21

28-039

www.hilbro.net

EN Bone Holding Forceps

DE Knochenhalte­zangen

ES Pinzas para huesos

Hilbro

BONE SURGERY



DINGMANN
28.0840.19 19.0cm



DINGMANN (Modif)
28.0842.19 19.0cm



LEWIN
28.0846.17 17.5cm

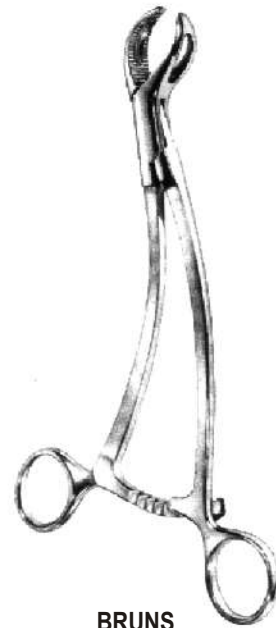

BRUNS
28.0850.18 18.5cm

28.0850.18

28-040

www.hilbro.net

Bone Holding Forceps EN

Knochenhaltezangen DE

Pinzas para huesos ES

28

BONE SURGERY

Hilbro



28.0854.13 13.5cm



28.0860.12 12.0cm



28.0864.13 13.5cm



28.0870.14 14.0cm



HAASE
28.0874.16 16.5 cm

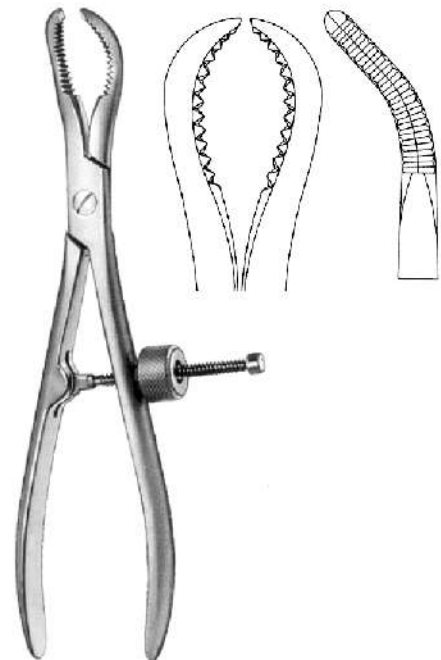

28.0880.16 16.0 cm
28.0880.24 24.0cm

28.0880.24

28-041

www.hilbro.net

28

EN Bone Holding Forceps

DE Knochenhalte­zangen

ES Pinzas para huesos

Hilbro

BONE SURGERY



28.0890.19 19.0cm



28.0890.23 23.0cm



28.0892.25 25.0cm

28.0892.25

28-042

www.hilbro.net

Bone Holding Forceps EN

Knochenhaltezangen DE

Pinzas para huesos ES

28

BONE SURGERY

Hilbro



28.0896.18 18.5cm

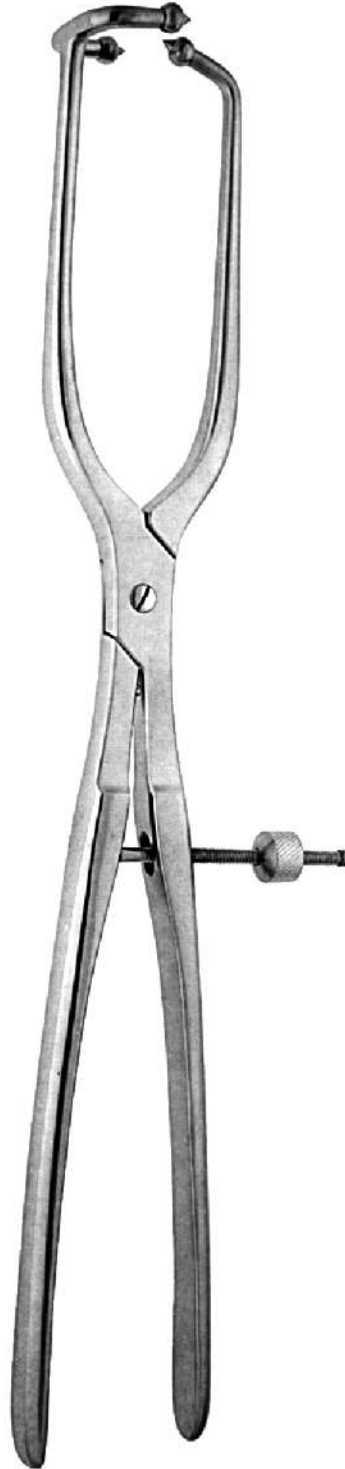

28.0900.40 40.0cm

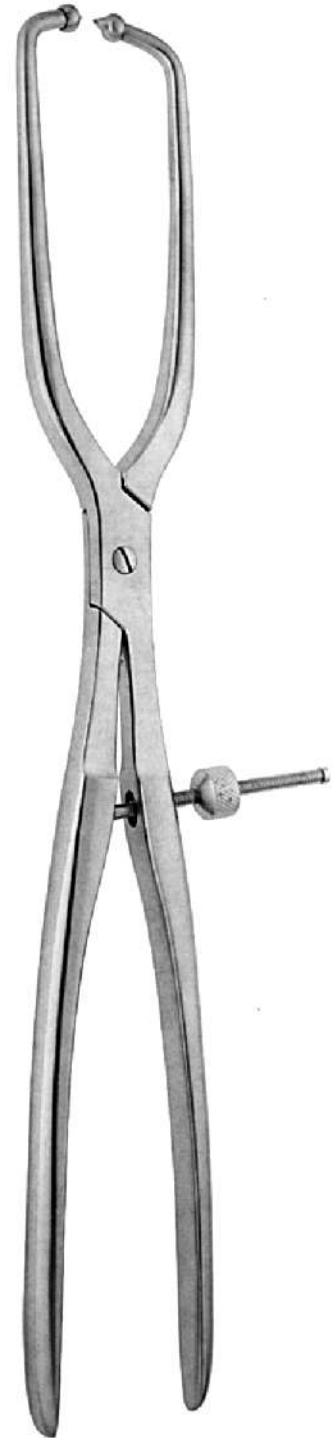

28.0902.40 40.0cm

28.0902.40

28-043

www.hilbro.net

EN Bone Holding Forceps

DE Knochenhaltezaugen

ES Pinzas para huesos

Hilbro

BONE SURGERY

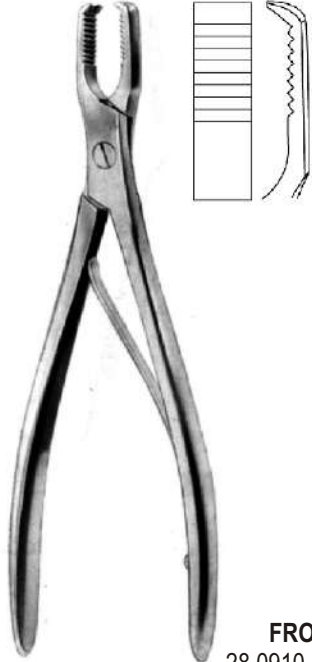

FROSCH
28.0910.18 18.0cm

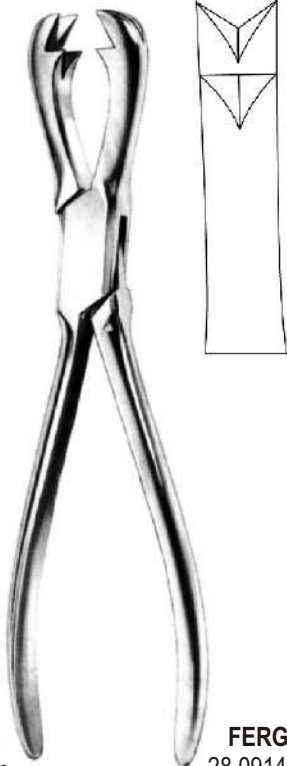

FERGUSSON
28.0914.21 21.0cm



LANGENBECK
28.0920.21 21.0cm



28.0924.20 20cm

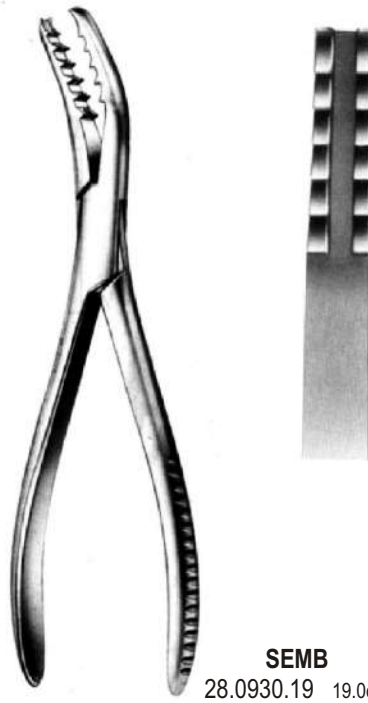

SEMB
28.0930.19 19.0cm



SEMB
28.0934.19 19.0cm

28.0934.19

28-044

www.hilbro.net

Bone Holding Forceps EN

Knochenhaltezangen DE

Pinzas para huesos ES

28

BONE SURGERY

Hilbro

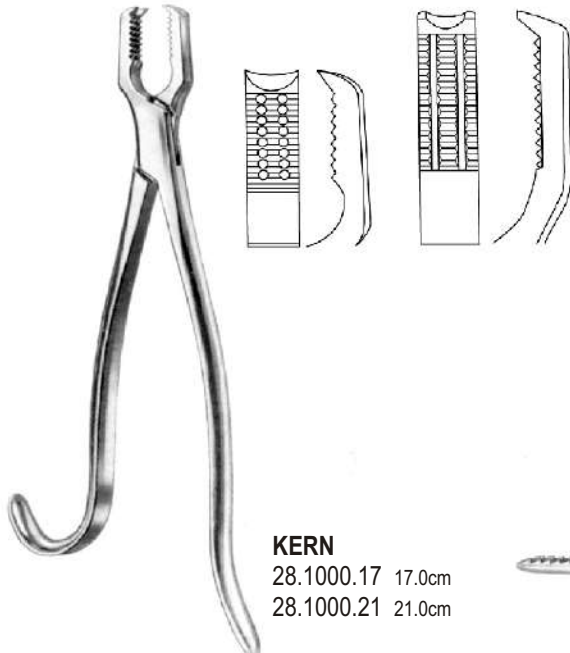

KERN
28.1000.17 17.0cm
28.1000.21 21.0cm

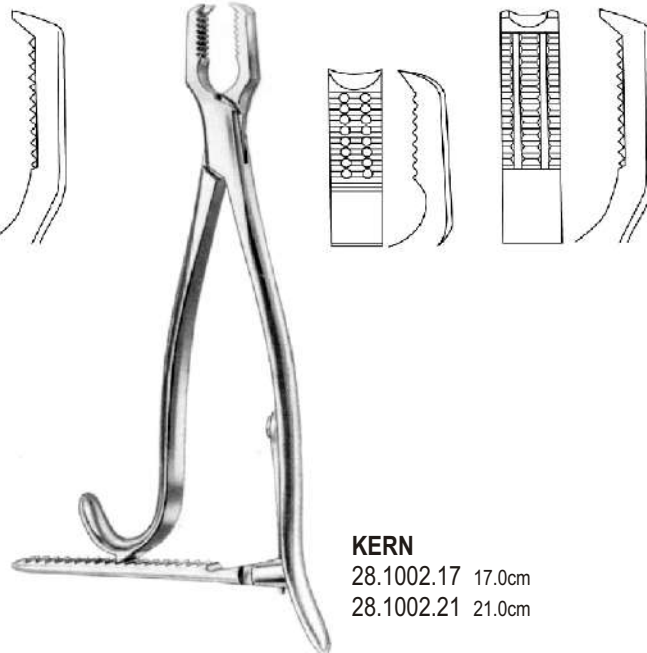

KERN
28.1002.17 17.0cm
28.1002.21 21.0cm

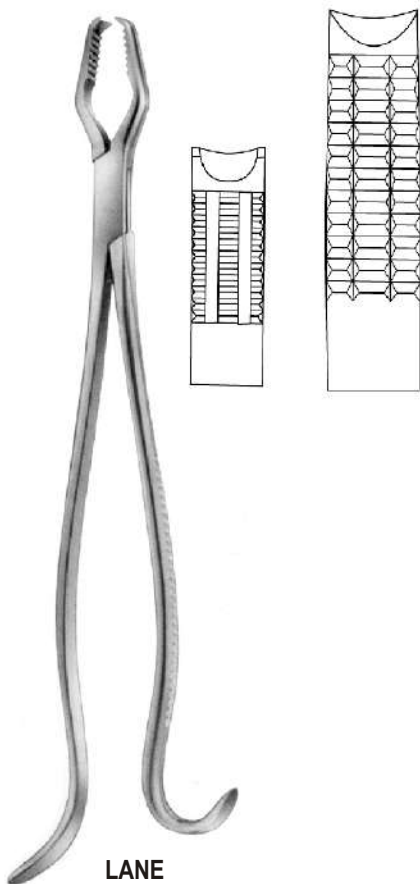

LANE
28.1004.33 33.0cm
28.1004.45 45.0cm

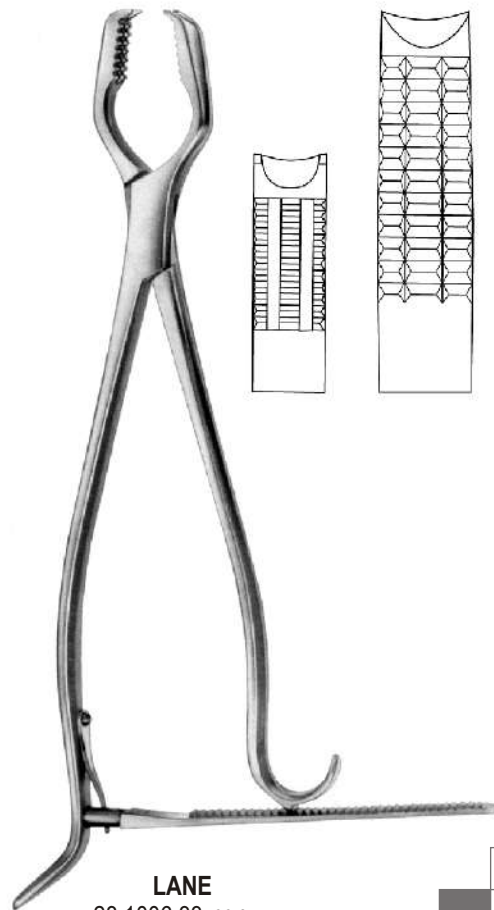

LANE
28.1006.33 33.0cm
28.1006.45 45.0cm

28.1006.45

28-045

www.hilbro.net

28

EN Bone Holding Forceps

DE Knochenhalte­zangen

ES Pinzas para huesos

Hilbro

BONE SURGERY



FARABEUF
28.1010.23 23.0cm
28.1010.26 26.0cm



FARABEUF-LAMBOTTE
28.1014.26 26.0cm



TUFFIER
28.1020.27 27.0cm

28.1020.27

28-046

www.hilbro.net

Bone Holding Forceps EN

Knochenhaltezangen DE

Pinzas para huesos ES

28

BONE SURGERY

Hilbro



LAMBOTTE
28.1030.22 22.0cm
28.1030.27 27.0cm
28.1030.30 30.0cm



LAMBOTTE
28.1032.22 22.0cm
28.1032.26 26.0cm
28.1032.33 33.0cm



LAMBOTTE
28.1034.19 19.0cm
28.1034.23 23.0cm
28.1034.26 26.0cm

28.1034.26

28-047

www.hilbro.net

EN Bone Holding Forceps

DE Knochenhaltezaugen

ES Pinzas para huesos

Hilbro

BONE SURGERY



ULRICH
28.1040.23 - 28.1040.28

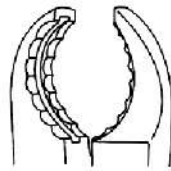
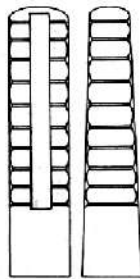

28.1040.23 23.0cm
28.1044.22 22.0cm



28.1040.25 25.0cm
28.1044.24 24.0cm

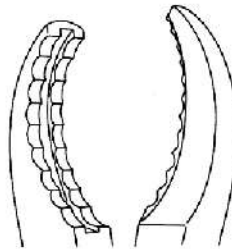

28.1040.28 28.0cm
28.1044.27 27.0cm



ULRICH
28.1044.22 - 28.1044.27

28.1044.27

28-048

www.hilbro.net

Bone Holding Forceps EN

Knochenhaltezangen DE

Pinzas para huesos ES

28

BONE SURGERY

Hilbro



28.1050.19 19.0cm
28.1050.26 26.0cm

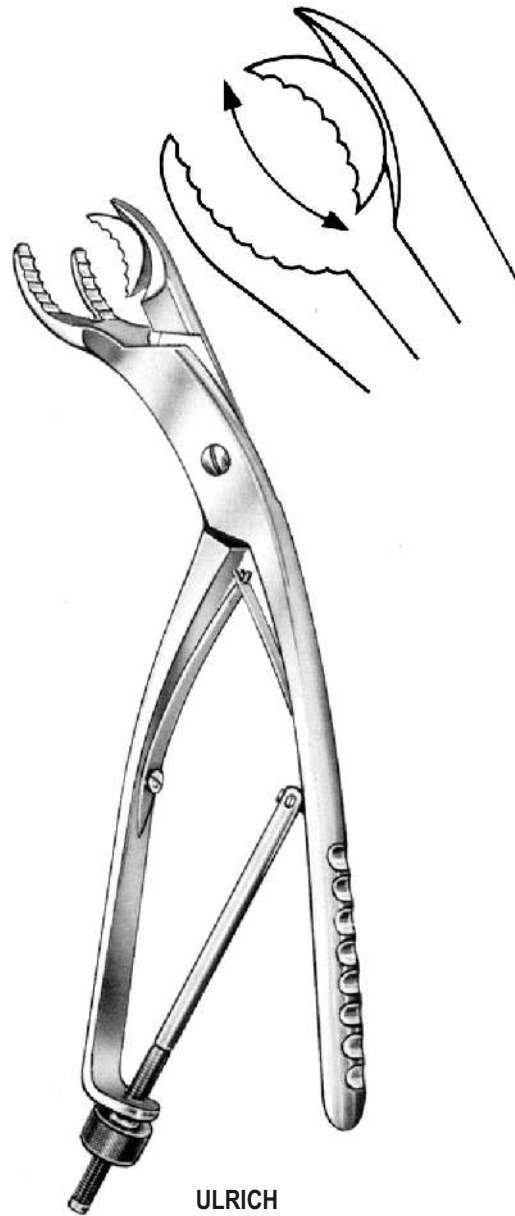

ULRICH
28.1054.28 28.0cm

28.1054.28

28-049

www.hilbro.net

EN Bone Holding Forceps

DE Knochenhaltezangen

ES Pinzas para huesos



BONE SURGERY



LOWMAN

- 28.1060.12 12.0cm
- 28.1060.18 18.5cm
- 28.1060.20 20.0cm
- 28.1060.22 22.0cm



GERSTER-LOWMANN

- 28.1064.18 18.0cm
- 28.1064.20 20.0cm
- 28.1064.22 22.0cm



LAMBERT-LOWMAN

- 2x2 prongs
- 28.1070.18 18.0cm
- 28.1070.20 20.0cm
- 28.1070.22 22.0cm



LOWMAN-HOGLUND

- 28.1074.12 12.0cm
- 28.1074.17 17.5cm
- 28.1074.20 20.0cm
- 28.1074.22 22.0cm

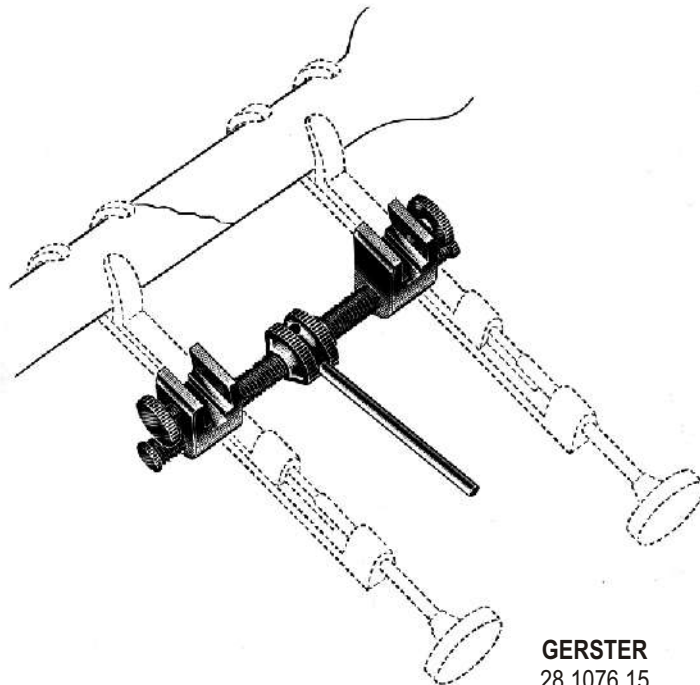

GERSTER

28.1076.15

28.1076.15

28-050

www.hilbro.net

Bone Holding Forceps EN

Knochenhaltezangen DE

Pinzas para huesos ES

28

BONE SURGERY

Hilbro



VERBRUGGE
28.1080.17 17.5cm

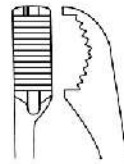

VERBRUGGE
28.1082.17 17.5cm

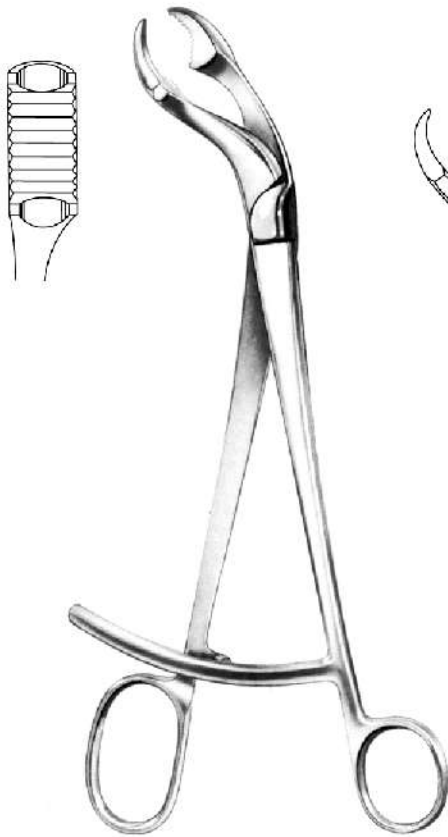
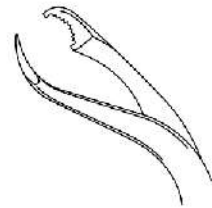

VERBRUGGE

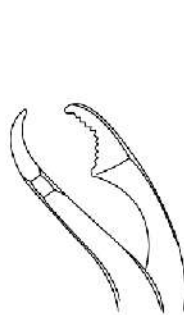
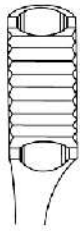

28.1084.25 25.0cm

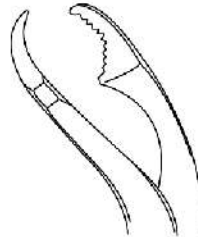

28.1084.26 26.0cm

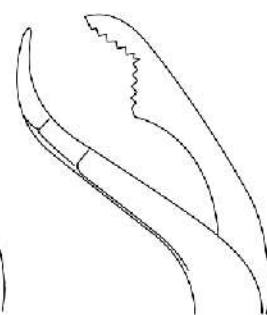

28.1084.27 27.0cm

28.1084.27

28-051

www.hilbro.net

28

EN Bone Holding Forceps

DE Knochenhalte­zangen

ES Pinzas para huesos

Hilbro

BONE SURGERY

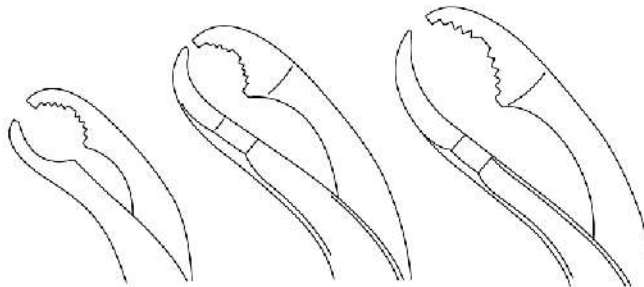
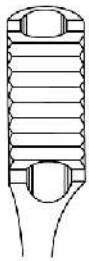

28.1090.15 15.0cm

28.1090.19 19.0cm

28.1090.24 24.0cm

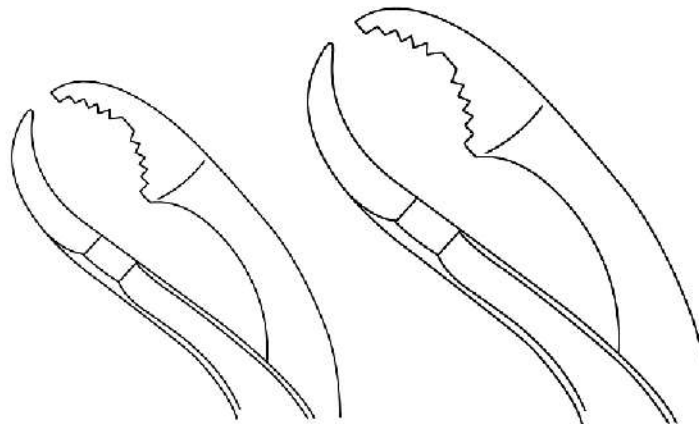

28.1090.26 26.0cm

28.1090.28 28.0cm

28.1090.28

28-052

www.hilbro.net

Amputation Retractor EN
Amputationsschild DE
Retractor para amputación ES

28

BONE SURGERY

Hilbro



PERCY
28.1094.00

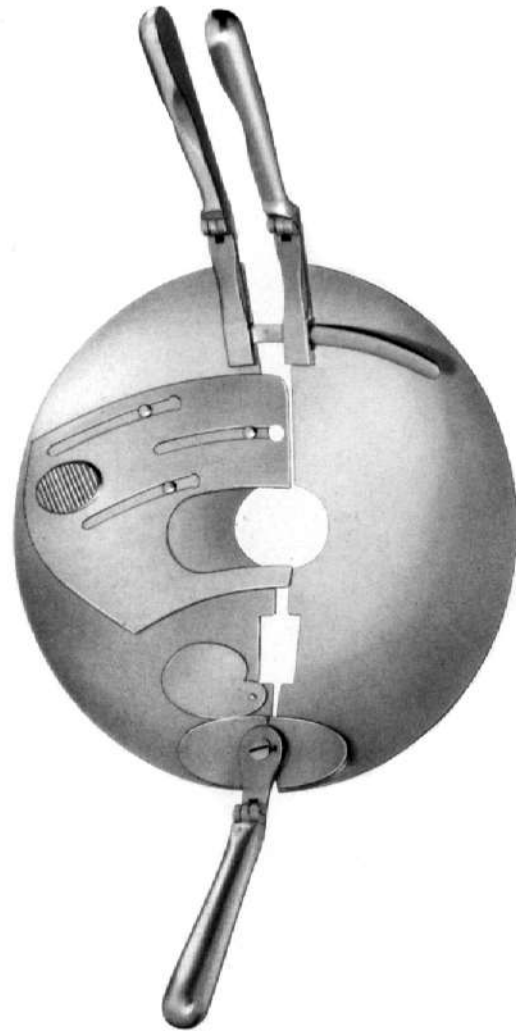

PERCY
28.1096.00

28.1096.00

28-053

www.hilbro.net

28

EN Tendon Stripper, Tendon Tunnel

DE Sehnenstripper, Durchzug

ES Separadores para tendones, para el tunel del tendon

Hilbro

BONE SURGERY

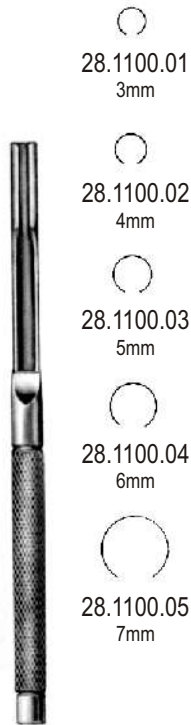

28.1100.01
3mm

28.1100.02
4mm

28.1100.03
5mm

28.1100.04
6mm

28.1100.05
7mm

BUNNELL
15.0cm



28.1104.40
4mm

28.1104.45
4.5mm

28.1104.55
5.5mm

23.0cm



28.1110.01
screw only

28.1110.33 33.5cm

28.1110.33

28-054

www.hilbro.net

Tendon Stripper, Tendon Tunnel EN

Sehnenstripper, Durchzug DE

Separadores para tendones, para el túnel del tendón ES

28

BONE SURGERY

Hilbro



BUNNEL
28.1114.23 23.0cm



28.1120.28 28.5cm



FISCHER
28.1124.31 31.0cm

28.1124.31

28-055

www.hilbro.net



BONE SURGERY



IDEAL
28.1130.10 handle only
28.1130.00 set



28.1130.01



28.1130.02



28.1130.03



28.1134.01 adult
28.1134.02 child

28.1134.02

28-056

www.hilbro.net

Bone Rongeur Forceps EN

Hohlmessselzangen DE

Pinzas-gubias ES

28

BONE SURGERY

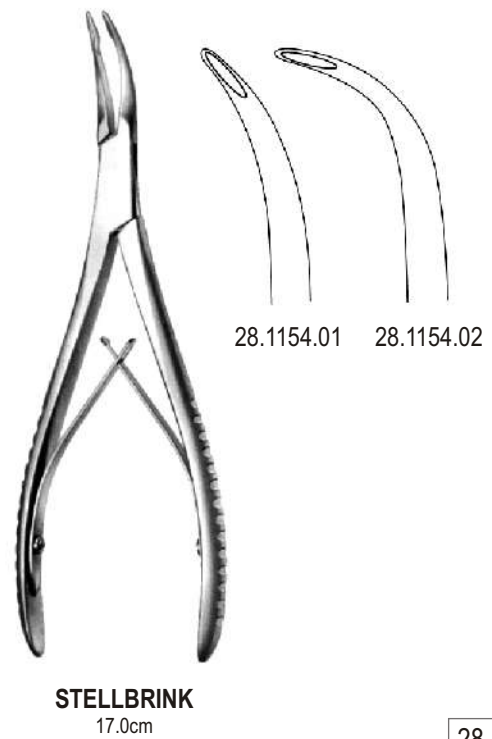
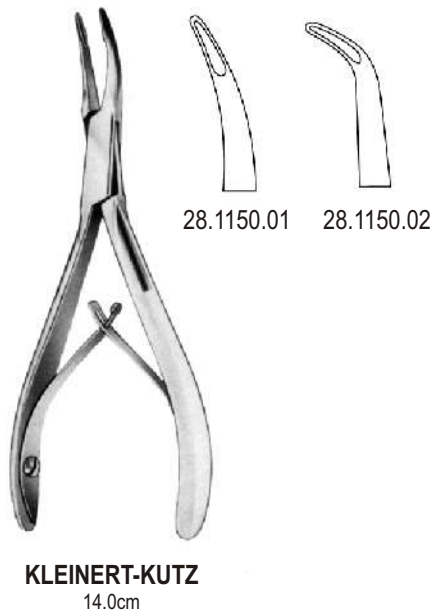

28.1154.02

28-057

www.hilbro.net

EN Bone Rongeur Forceps

DE Hohlmesselzangen

ES Pinzas-gubias

Hilbro

BONE SURGERY



MINI-FRIEDMAN
28.1160.12 12.0cm



FRIEDMAN
28.1160.14 14.0cm



MEAD
28.1164.16 16.5cm



MEAD
28.1166.16 16.5cm



HARTMANN
28.1170.16 16.0cm

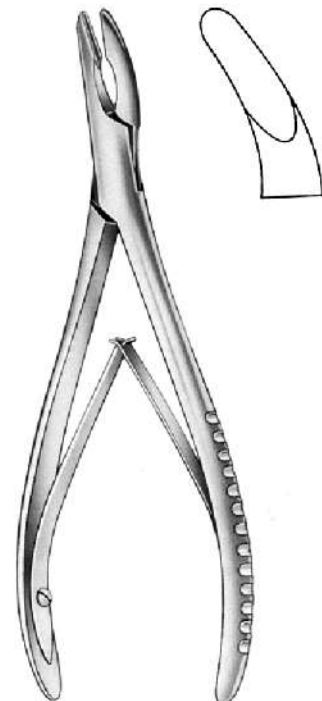

HARTMANN
28.1170.18 18.5cm

28.1170.18

28-058

www.hilbro.net

Bone Rongeur Forceps EN

Hohlmessenzangen DE

Pinzas-gubias ES

28

BONE SURGERY



JANSEN
18.0cm



28.1174.01



28.1174.02



28.1174.03

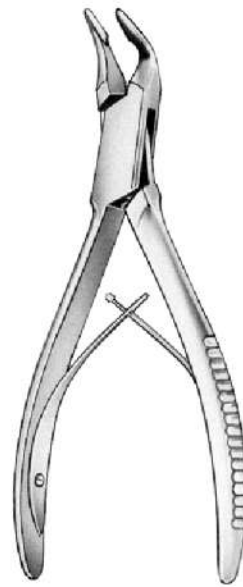

BLUMENTHAL
15.0cm



28.1180.01



28.1180.02



28.1180.03



LEMPERT
20.0cm



28.1184.20



28.1185.20

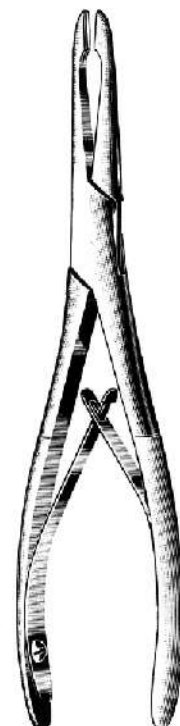

DEFOURMENTEL
28.1190.19 19.0cm



28.1190.19

28-059

www.hilbro.net

EN Bone Rongeur Forceps

DE Hohlmesselzangen

ES Pinzas-gubias



BONE SURGERY

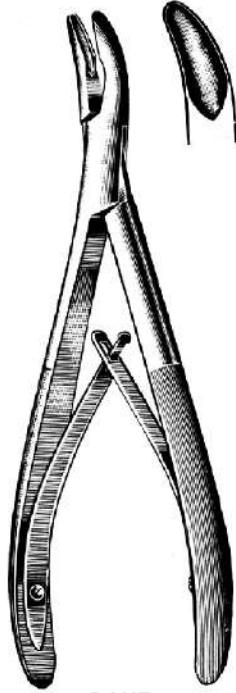

BANE
28.1194.18 18.0cm



ADSON
28.1200.21 21.0cm

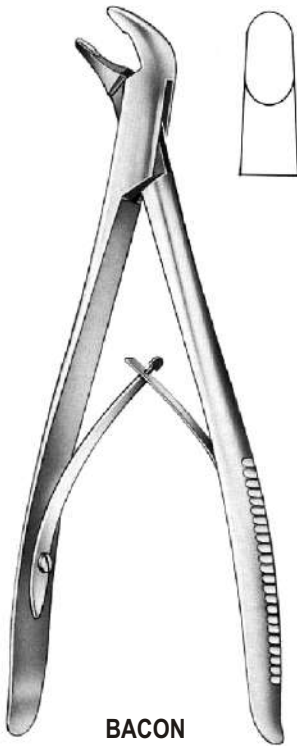

BACON
28.1204.20 20.0cm



FISCH
17.0cm



28.1210.01



28.1210.02

28.1210.02

28-060

www.hilbro.net

Bone Rongeur Forceps EN

Hohlmessselzangen DE

Pinzas-gubias ES

28

BONE SURGERY

Hilbro



LUER
28.1214.01 15.0cm

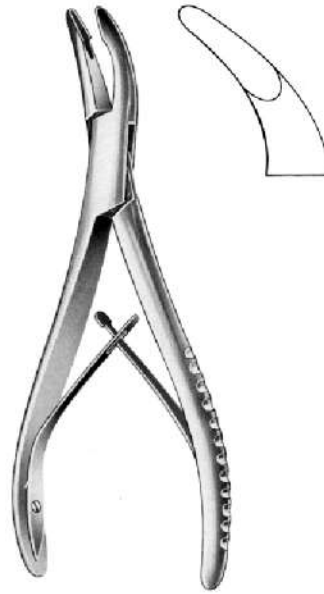

LUER
28.1214.02 15.0cm

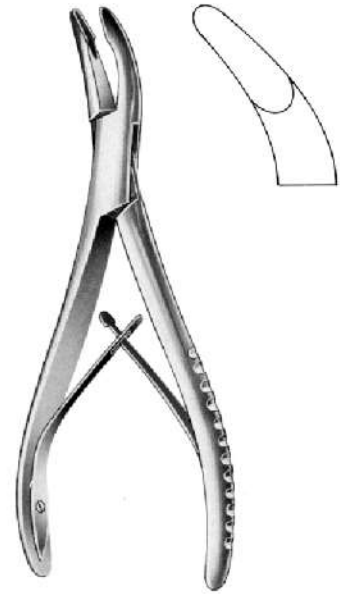

LUER
28.1214.03 15.0cm



LUER
28.1220.01 15.0cm



LUER
28.1220.02 15.0cm

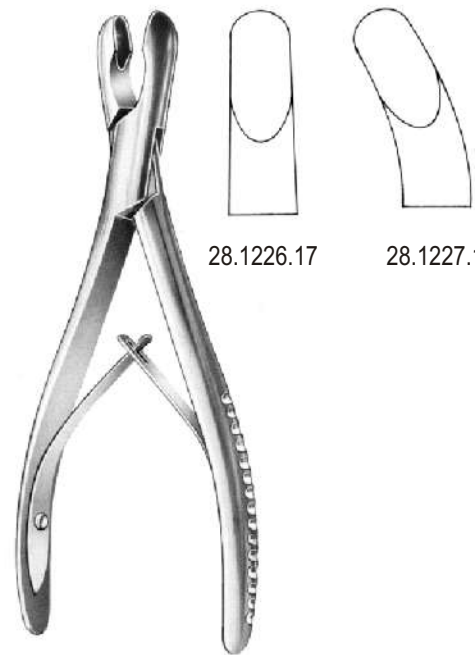

LUER
17.0cm

28.1226.17

28.1227.17

28.1227.17

28-061

www.hilbro.net

EN Bone Rongeur Forceps

DE Hohlmesselzangen

ES Pinzas-gubias

Hilbro

BONE SURGERY

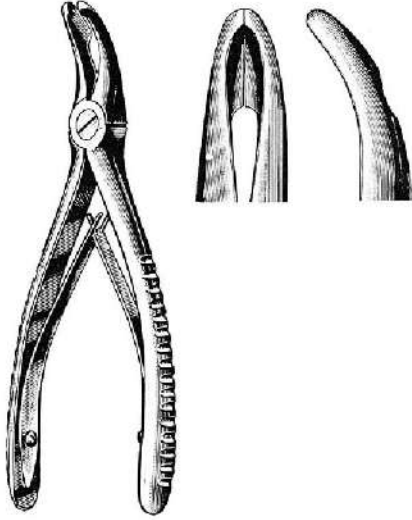

UNIVERSAL
28.1230.13 13.5cm

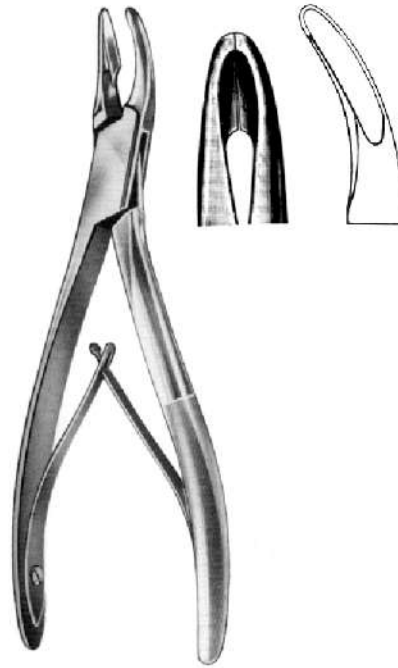

SHELL
28.1234.17 17.0cm

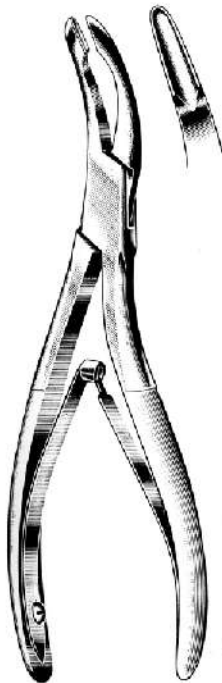

COTTLE-JANSEN
28.1240.18 18.0cm

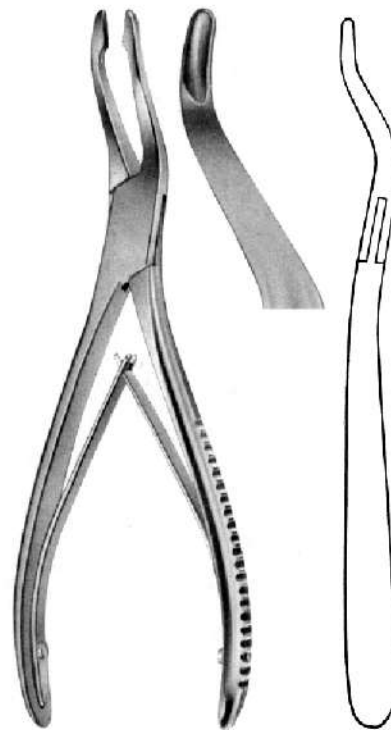

JANSEN
28.1244.19 19.0cm

28.1244.19

28-062

www.hilbro.net

Bone Rongeur Forceps EN

Hohlmessselzangen DE

Pinzas-gubias ES

28

BONE SURGERY

Hilbro

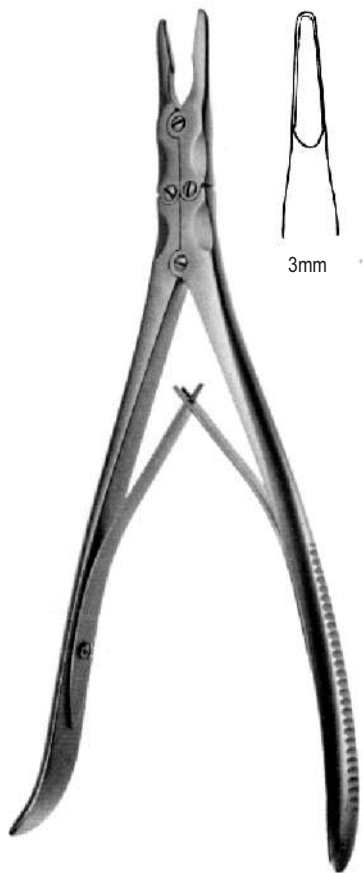

SMITH-PETERSEN
28.1250.01 24.0cm

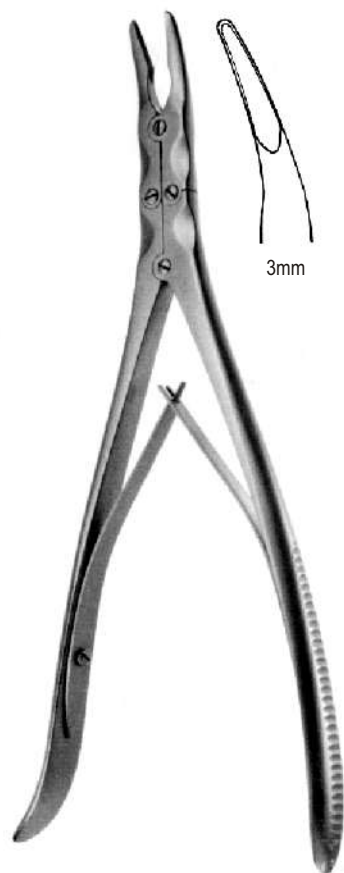

SMITH-PETERSEN
28.1250.02 24.0cm



SMITH-PETERSEN
28.1250.03 24.0cm

28.1250.03

28-063

www.hilbro.net

EN Bone Rongeur Forceps

DE Hohlmesselzangen

ES Pinzas-gubias

Hilbro

BONE SURGERY

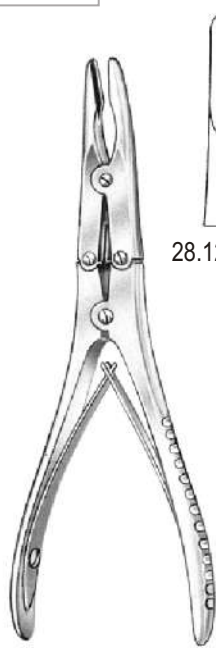

28.1254.15



28.1255.15

BÖHLER
15.5cm

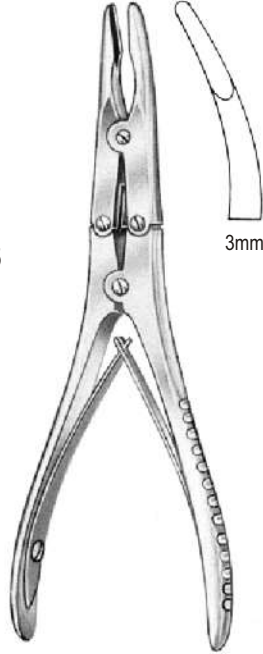

3mm

KLEINERT-KUTZ
28.1260.15 15.0cm



3mm

GEIGER
28.1264.15 15.0cm

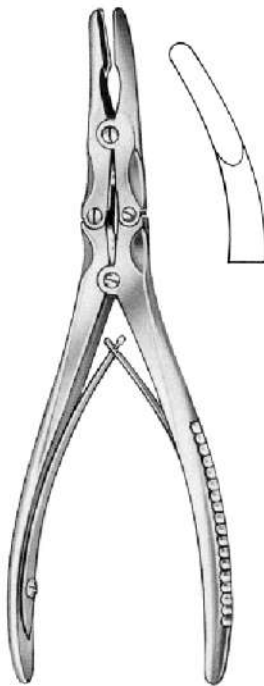

BEYER
28.1270.18 18.0cm

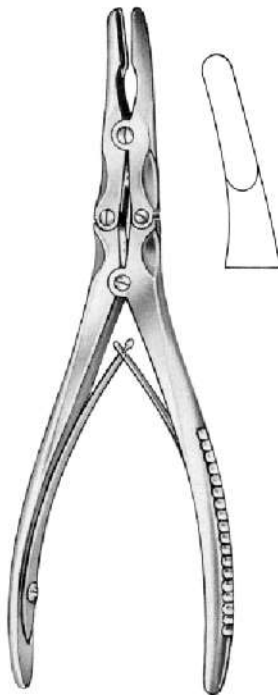

ZAUFAL-JANSEN
28.1274.18 18.0cm

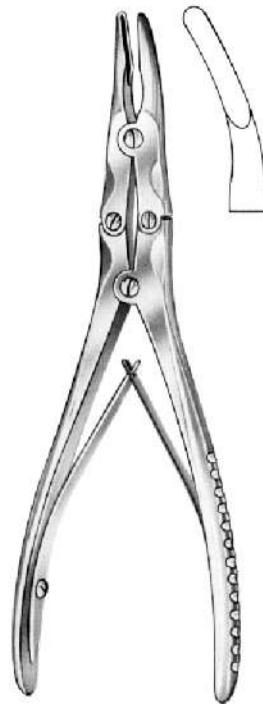

MAYFIELD
28.1280.17 17.0cm

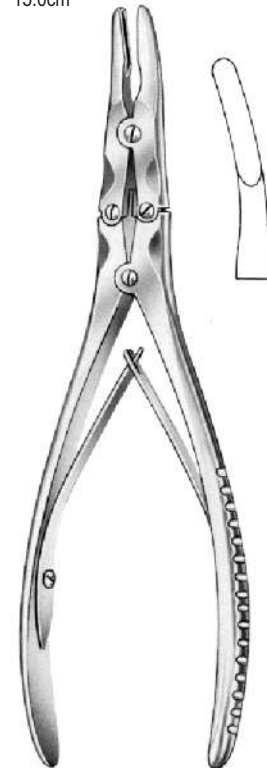

MARQUARDT
28.1284.20 20.0cm

28.1284.20

28-064

www.hilbro.net

Bone Rongeur Forceps EN

Hohlmessenzangen DE

Pinzas-gubias ES

28

BONE SURGERY



28.1290.02
2mm

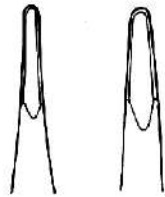

28.1290.03
3mm



28.1291.02
2mm



28.1291.03
3mm



4mm

PEIPER-BEYER
28.1294.18 18.0cm

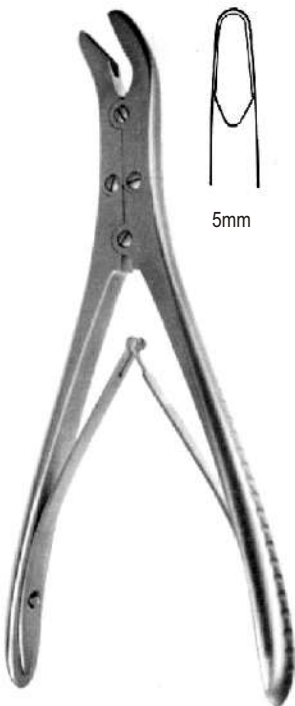

5mm

RUSKIN
28.1300.18 18.0cm



28.1304.18



28.1305.18

RUSKIN
18.0cm



28.1310.23



28.1311.23

RUSKIN
23.0cm

28.1311.23

28-065

www.hilbro.net

28

EN Bone Rongeur Forceps

DE Hohlmessselzangen

ES Pinzas-gubias

Hilbro

BONE SURGERY



FRYKHOLM
28.1316.24 24cm



ECHLIN
23.0cm

28.1320.02

28.1320.03

28.1320.04

28.1320.04

28-066

www.hilbro.net

Bone Rongeur Forceps EN

Hohlmessselzangen DE

Pinzas-gubias ES

28

BONE SURGERY



5mm

STILLE-LEKSELL
28.1324.23 23.0cm



28.1330.05
5mm

28.1330.08
8mm

LEKSELL
23.0cm



28.1334.01

28.1334.02

LEKSELL-STILLE
24.0cm

28.1334.02

28-067

www.hilbro.net

28

EN Bone Rongeur Forceps

DE Hohlmesselzangen

ES Pinzas-gubias

Hilbro

BONE SURGERY



STILLE
28.1340.23 23.0cm



STILLE-RUSKIN
28.1344.23 23.0cm 28.1345.23



SEMB
28.1350.22 22.5cm

28.1350.22

28-068

www.hilbro.net

Bone Rongeur Forceps EN

Hohlmessselzangen DE

Pinzas-gubias ES

28

BONE SURGERY

Hilbro



STILLE-LUER

28.1354.22 22.0cm 28.1355.22



STILLE-LUER

28.1360.23 23.0cm 28.1361.23
28.1360.27 27.0cm 28.1361.27

28.1361.27

28-069

www.hilbro.net

28

EN Bone Rongeur Forceps

DE Hohlmesselzangen

ES Pinzas-gubias

Hilbro

BONE SURGERY



SAUERBRUCH
30.0cm

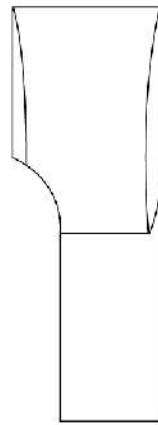

28.1364.01

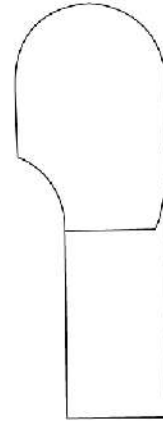

28.1364.02

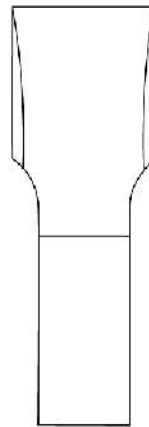

28.1366.01

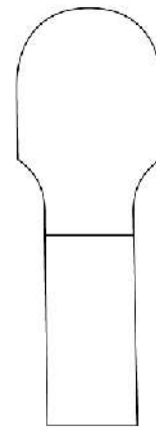

28.1366.02

28.1366.02

28-070

www.hilbro.net

Bone Cutting Forceps EN

Knochensplitterzangen DE

Pinzas cortantes para huesos ES

28

BONE SURGERY

Hilbro

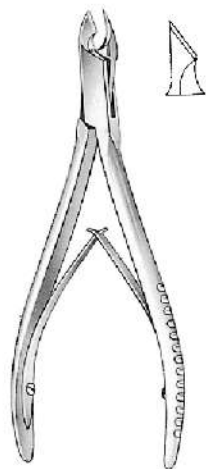

28.1370.12 12.0cm

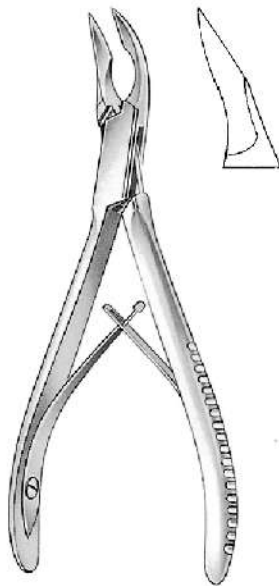

CLEVELAND
28.1374.15 15.0cm

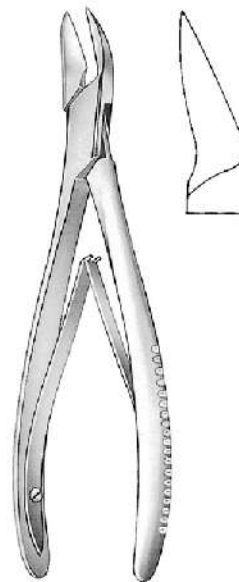

CLEVELAND
28.1376.17 17.0cm

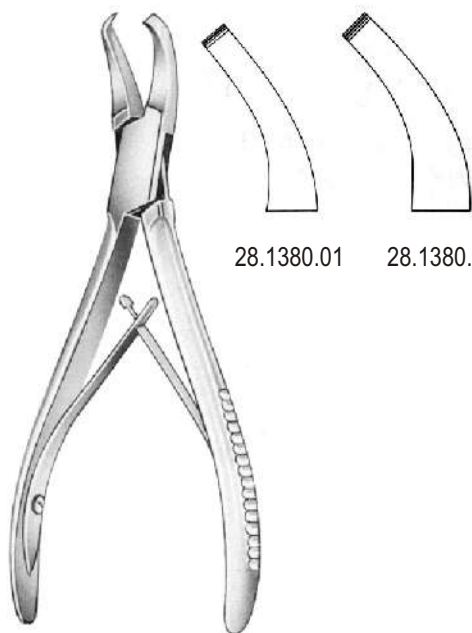

CLEVELAND
28.1380.01 16.0cm



28.1380.02

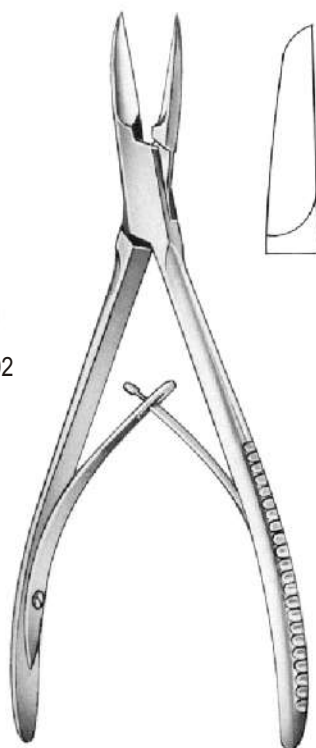

COTTLE-KAZANJIAN
28.1384.19 19.0cm



MARKWALDER
28.1390.20 20.0cm

28.1390.20

28-071

www.hilbro.net

BONE SURGERY

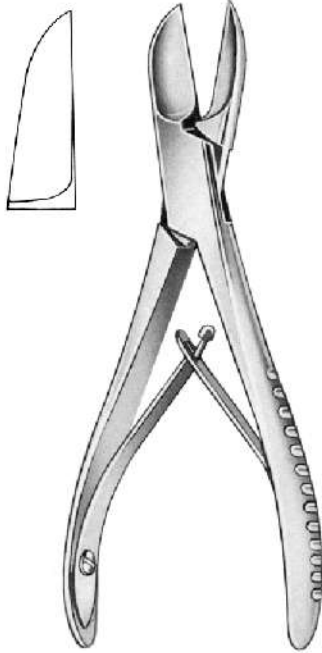

LISTON

28.1400.14 14.0cm 28.1401.14
 28.1400.17 17.0cm 28.1401.17
 28.1400.19 19.0cm 28.1401.19
 28.1400.22 22.0cm 28.1401.22

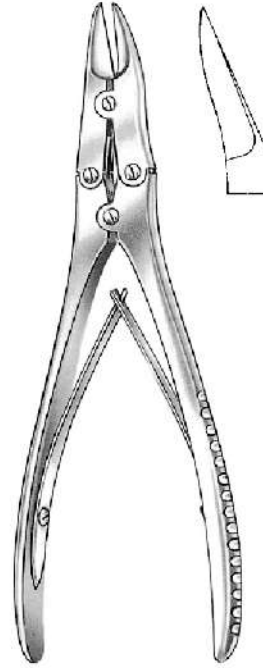

MC INDOE

28.1406.17 17.5cm



28.1410.15 15.0cm

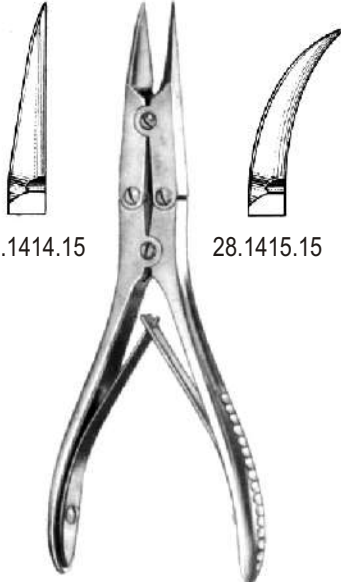

28.1414.15

28.1415.15

15.0cm

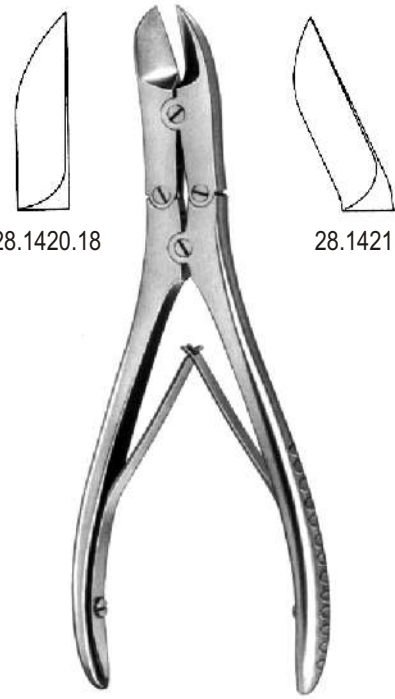

28.1420.18

28.1421.18

RUSKIN-LISTON

18.5cm

28.1421.18

28-072

www.hilbro.net

BONE SURGERY

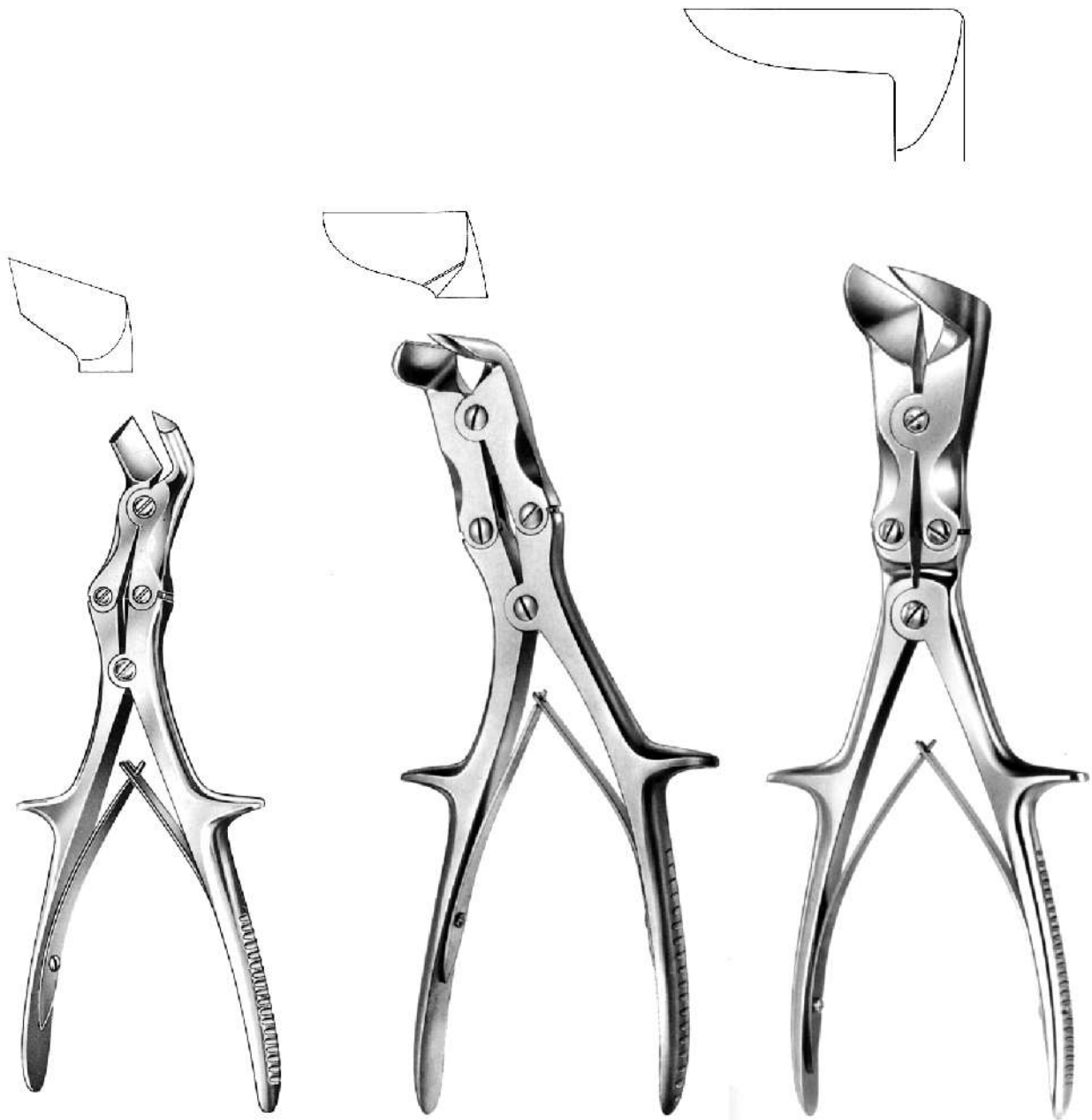

TUDOR-EDWARDS
28.1426.23 23.0cm

SEMB
28.1430.24 24.0cm

STILLE-LISTON
28.1434.27 27.0cm

28.1434.27

28-073

www.hilbro.net



BONE SURGERY

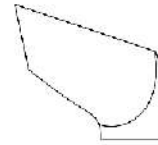
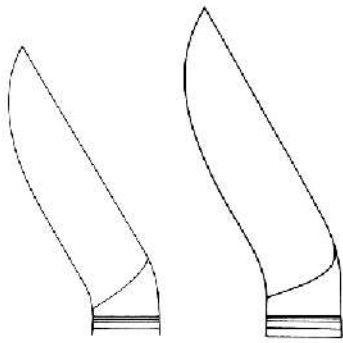

28.1441.23

28.1441.27



STILLE LISTON
 28.1440.27 27.0cm



STILLE LISTON
 28.1441.23 23.0cm
 28.1441.27 27.0cm



LISTON KEY
 28.1446.27 27.0cm

28.1446.27

28-074

www.hilbro.net

BONE SURGERY

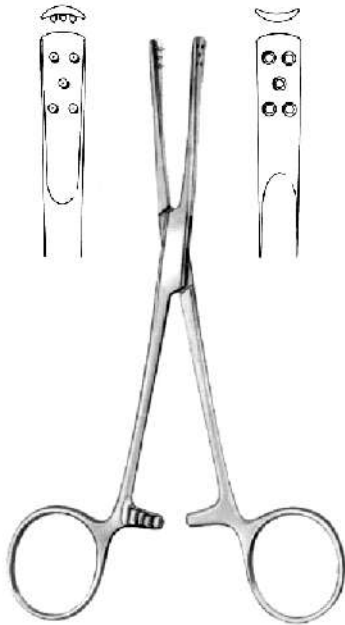

PENNER
 28.1450.15 15.5cm



RADOLF
 28.1454.13 13.5cm



28.1470.01 saw
 28.1470.02 key

28.1470.00 17.0cm



28.1472.01 saw
 28.1472.02 key

28.1472.00 17.0cm



28.1474.01 saw
 28.1474.02 key

WALTON
 28.1474.00 16.0cm

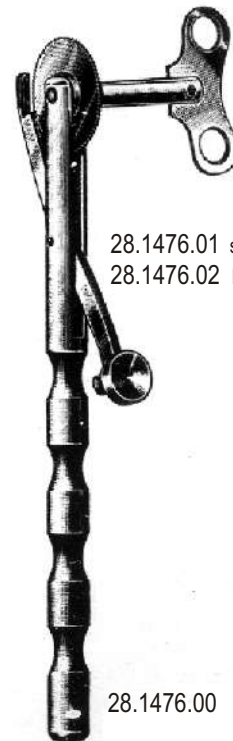

28.1476.01 saw
 28.1476.02 key

28.1476.00

28.1476.02

28-075

www.hilbro.net

28

EN Bone Spoon

DE Knochenlöffel

ES Cucharilla cortantes

Hilbro

BONE SURGERY



28.1480.26 26.5cm

28.1482.27 27.0cm

28.1484.28 28.0cm

28.1486.28 28.0cm

28.1488.00

28.1488.00

28-076

www.hilbro.net